

YLÄNE, ANIVEHMAANMÄKI

A-L Hirviluoto 1957

1:10

HAUTA XLVII 2a

Karttalite b

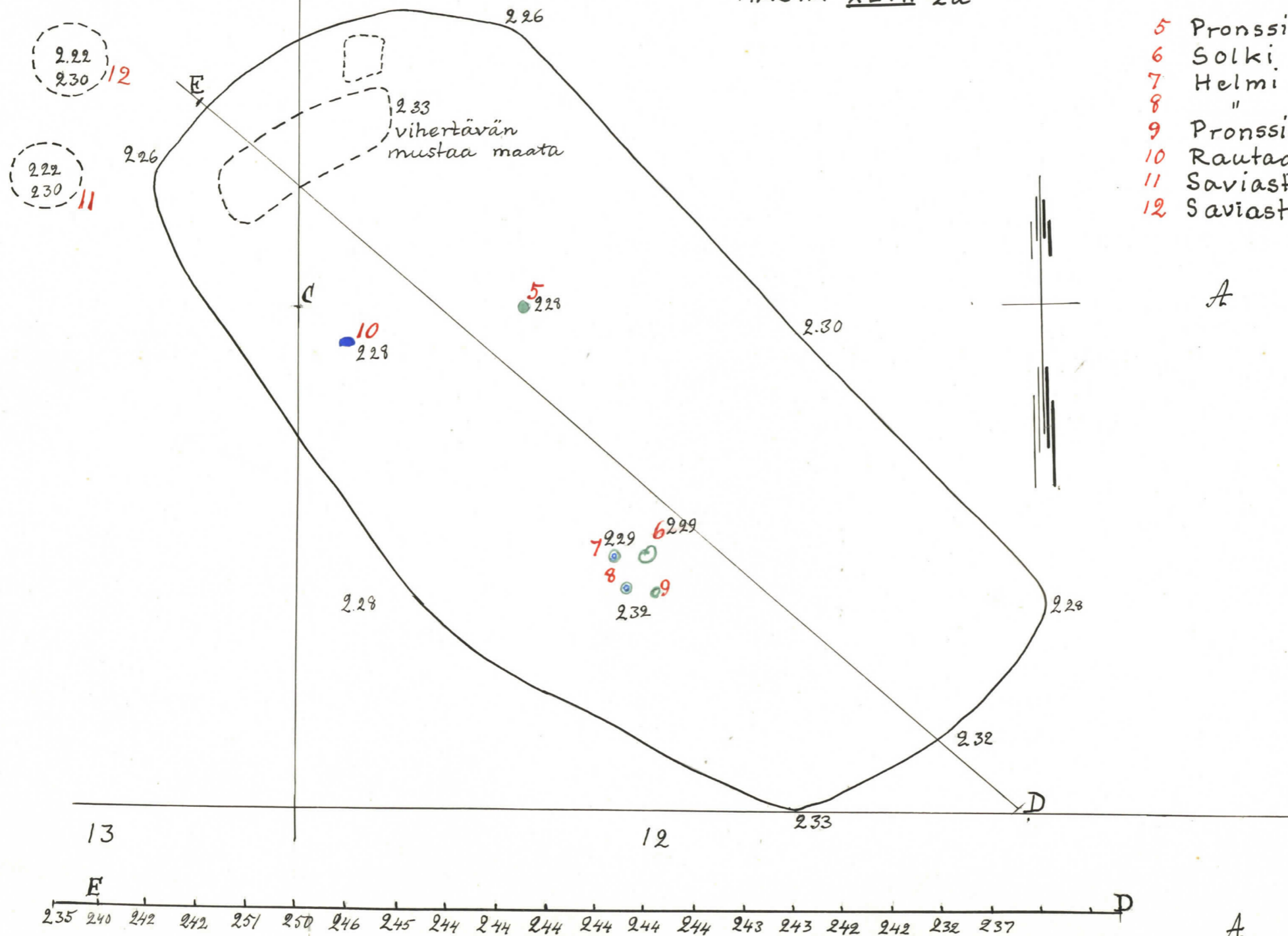

5	Pronssia	2.28	14196:4
6	Solki	2.29	" :6
7	Helmi	"	" :7
8	"	2.32	" :8
9	Pronssia	2.32	" :9
10	Rautaa	2.28	" :11
11	Saviastia	2.22	" :10
12	Saviastia	"	" :12

YLÄNE, ANIVEHMAANMÄKI

A-L HIRVILUOTO 1957

HAUTA XLVII |

1:10

- | | | | |
|---|--------------|-----|---------|
| 1 | Raudan pl | 219 | 14196:1 |
| 2 | Puukko " | 222 | " : 2 |
| 3 | Saviastia " | 217 | " : 3 |
| 4 | Pr. Sormus " | 222 | " : 5 |

--- nokialue
 - - - kuopan reuna

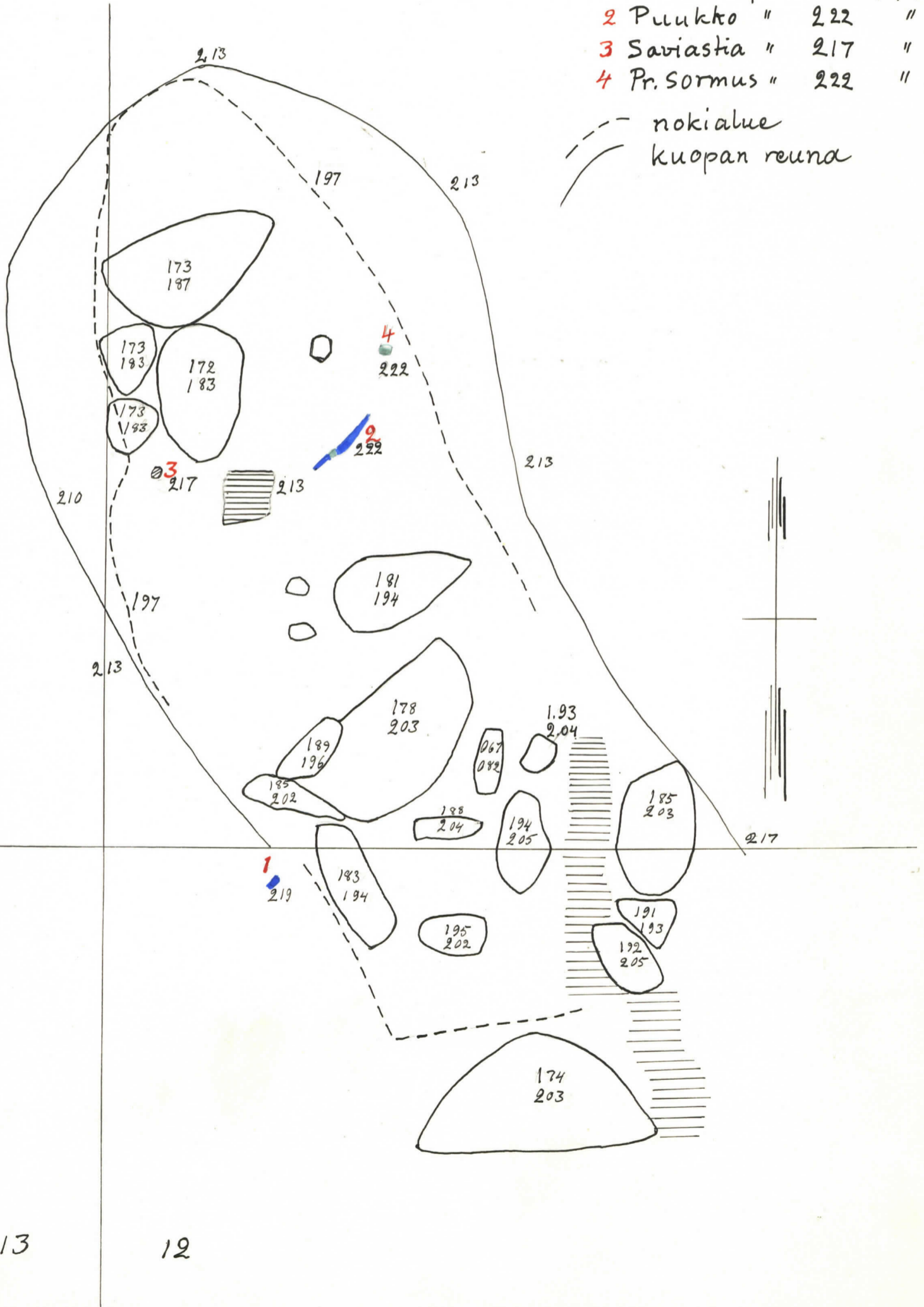

YLÄNE, ANIVEHMAANMÄKI
 A-L HIRVILUOTO 1957
 HAUTA XLVII 26
 1 : 10

B Karttaliite 5.
 ks. kartta 2a

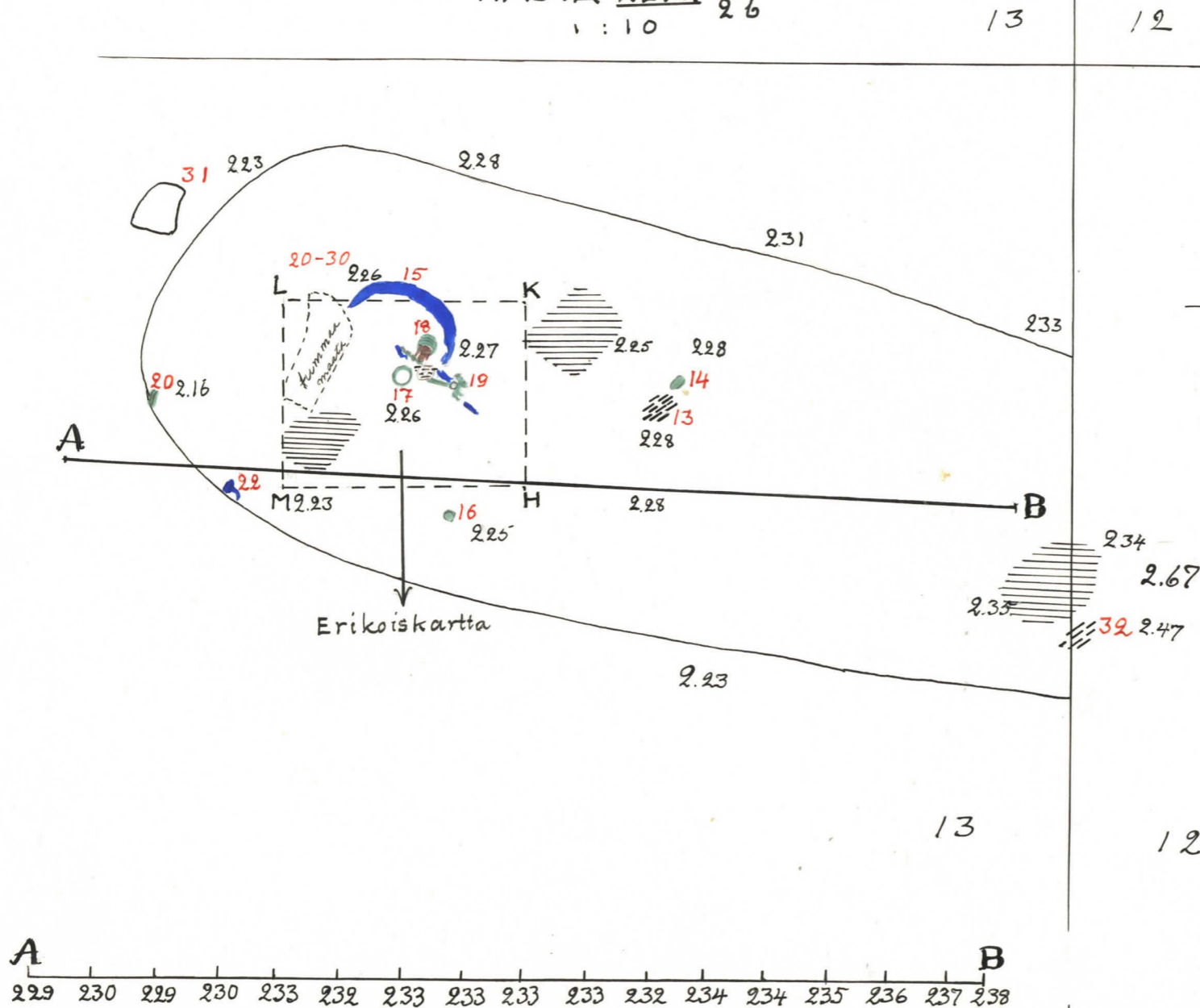

13	Hiiltä	228	14196	: 13
14	Pronssia	"	"	: 14
15	Sirppi	227-226	"	: 15
16	Pronssia	225	"	: 16
17	Rannerengas	226	"	: 17
18	"	"	227-225	: 21
19 ₁	Riipus	227		: 25
19 ₂	Rautavarras			: 31
19 ₃	Pronssikier.			: 32
19 ₄	Rautavarrasta			: 33
19 ₅	"	"		
20	Pronssikier.	216		: 34
21	Puuta	216		: 35
22	Rautanaula	223		: 36
23	Kelt. helmi	227		: 37
24	2 sinistä	224		: 38
25	1 " - "	"		: 39
26	- " - "	"		: 40
27	- " - "	"		: 41
28	Sin. lasihelmi	224		: 42
29	2 - " -	225		: 43
30	16 helmiä			: 44-59
31	Keram.	223		: 60
32	Hiiltä			: 61
33	2 helmeä	225		: 62-62

M
↑

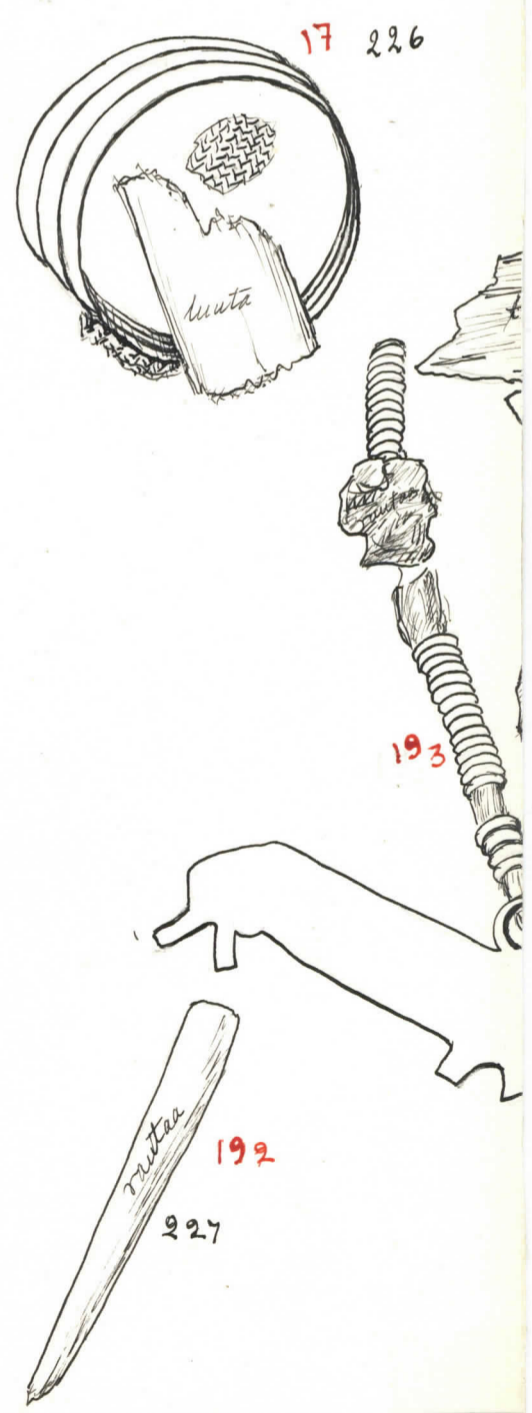
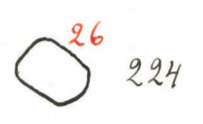
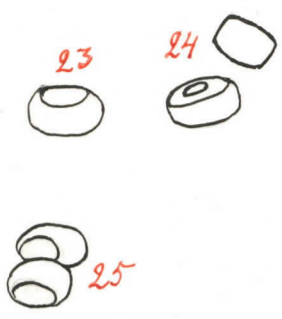

YLÄNE, ANIVEHMAANMÄKI
 HAUTA XLVII B ERIKOISKARTTA 1:1
 A-L Hirviluoto 1957

H

Karttaliite 7.

L
↑

226

224

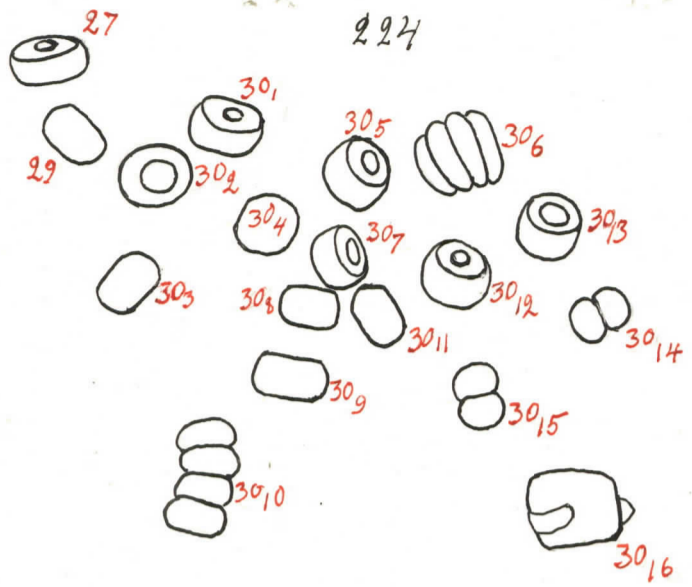

195



18 227

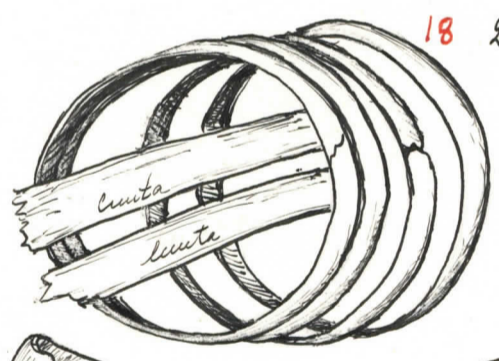

15 227



19

227



→ K

YLÄNE, ANIVEHMAANMÄKI
HAUTA XLVIII,
A-L Hirviluoto 1957
piirt. P. Huovari
1:10

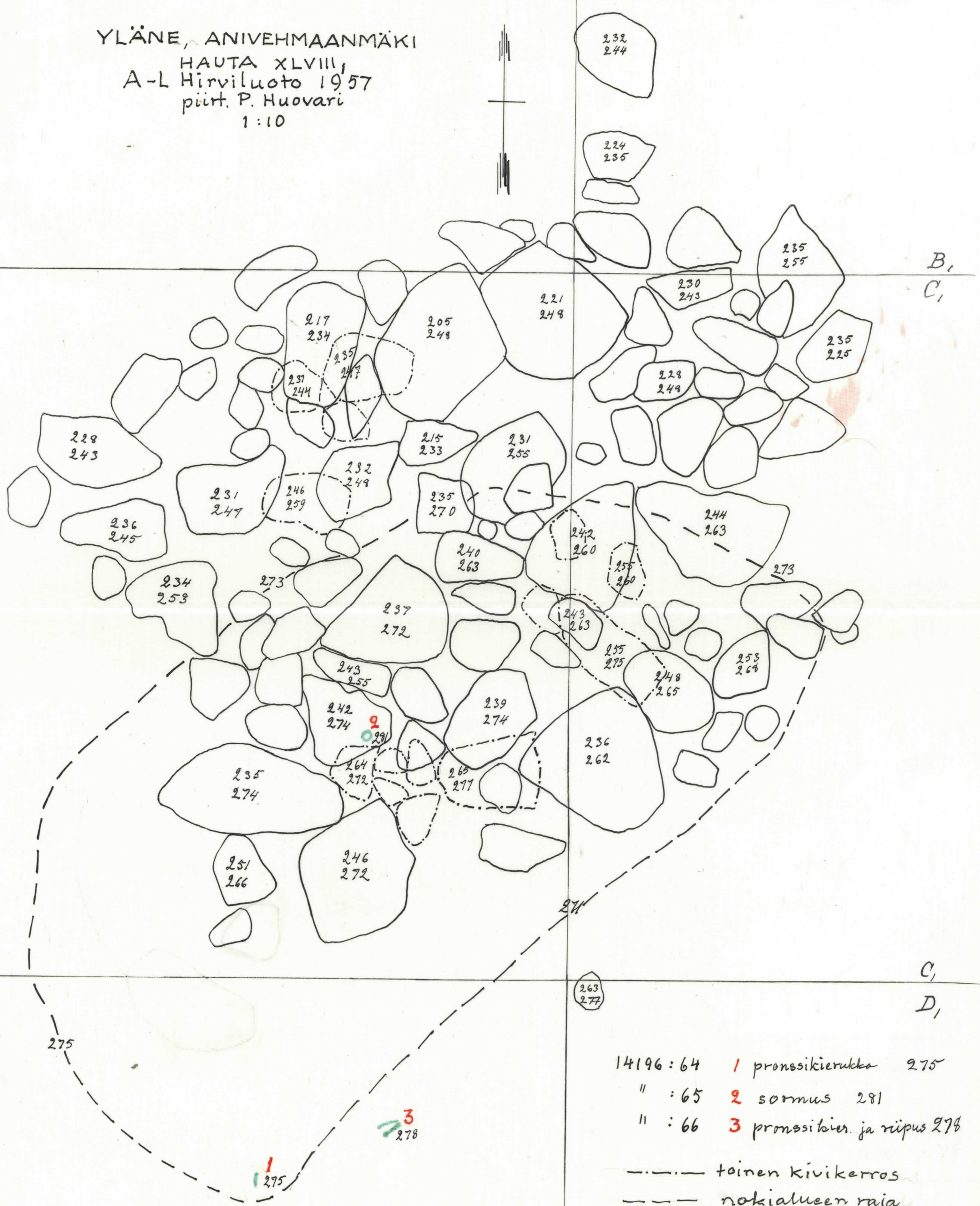

- 14196:64 1 pronssikierukka 275
- " :65 2 sormus 281
- " :66 3 pronssikier. ja riipus 278

----- toinen kivikerros
 - - - - - nokialueen raja

YLÄNE, ANIVEHMAANMÄKI
 HAUTA XLVIII₂
 A-L Hirviluoto 1957
 piirt. P. Huovari

14196: 67 4 pronssispiraali 302
 " : 68 5 " " 303

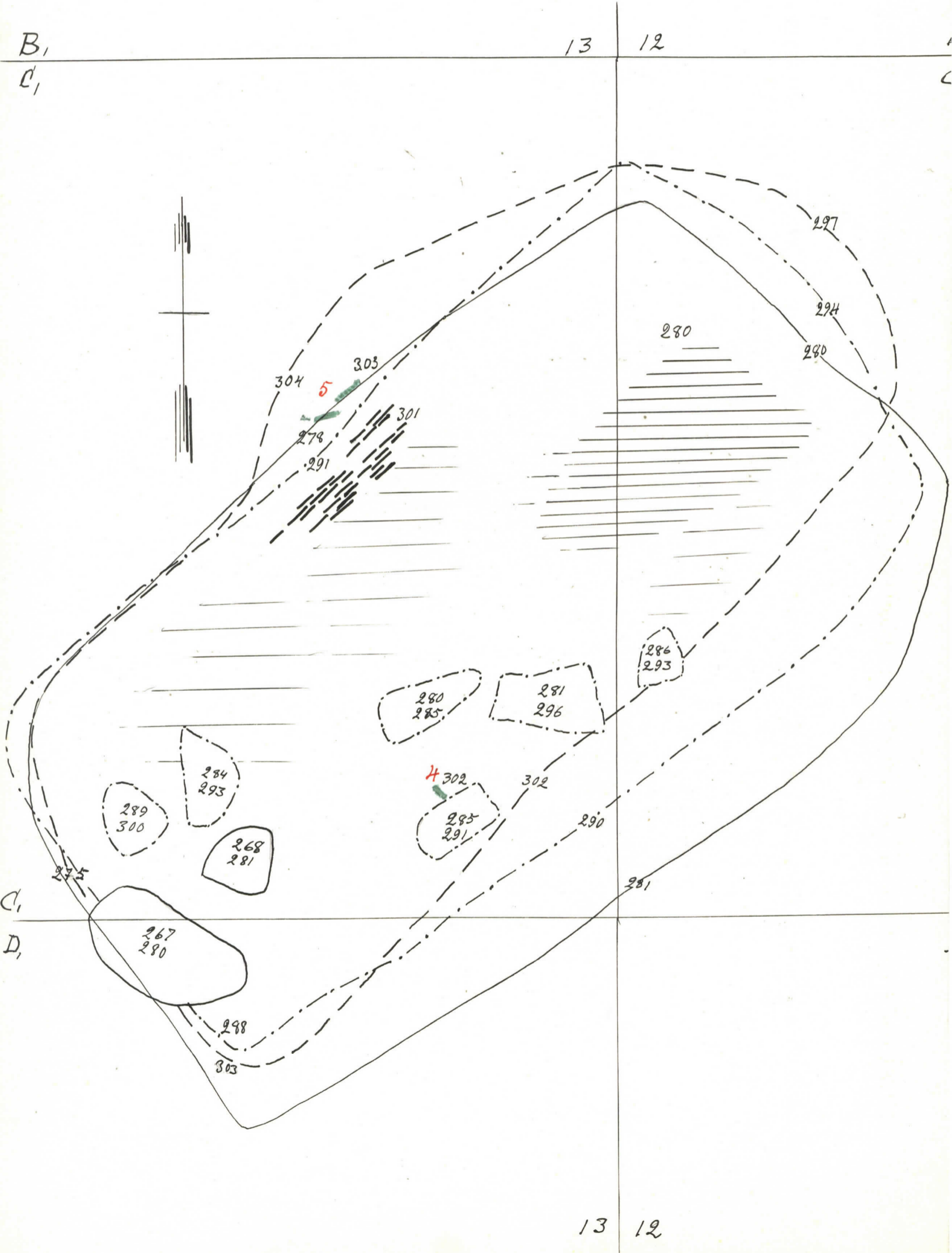

YLÄNE, ANIVEHMAANMÄKI

HAUTA XLVIII₃
A-L Hirvöiluoto 1957
piirt. P. Huovari
1:10

14196 : 69
" : 70
" : 71

Miekka 305-304
Solki 805
Keihäänk. 304

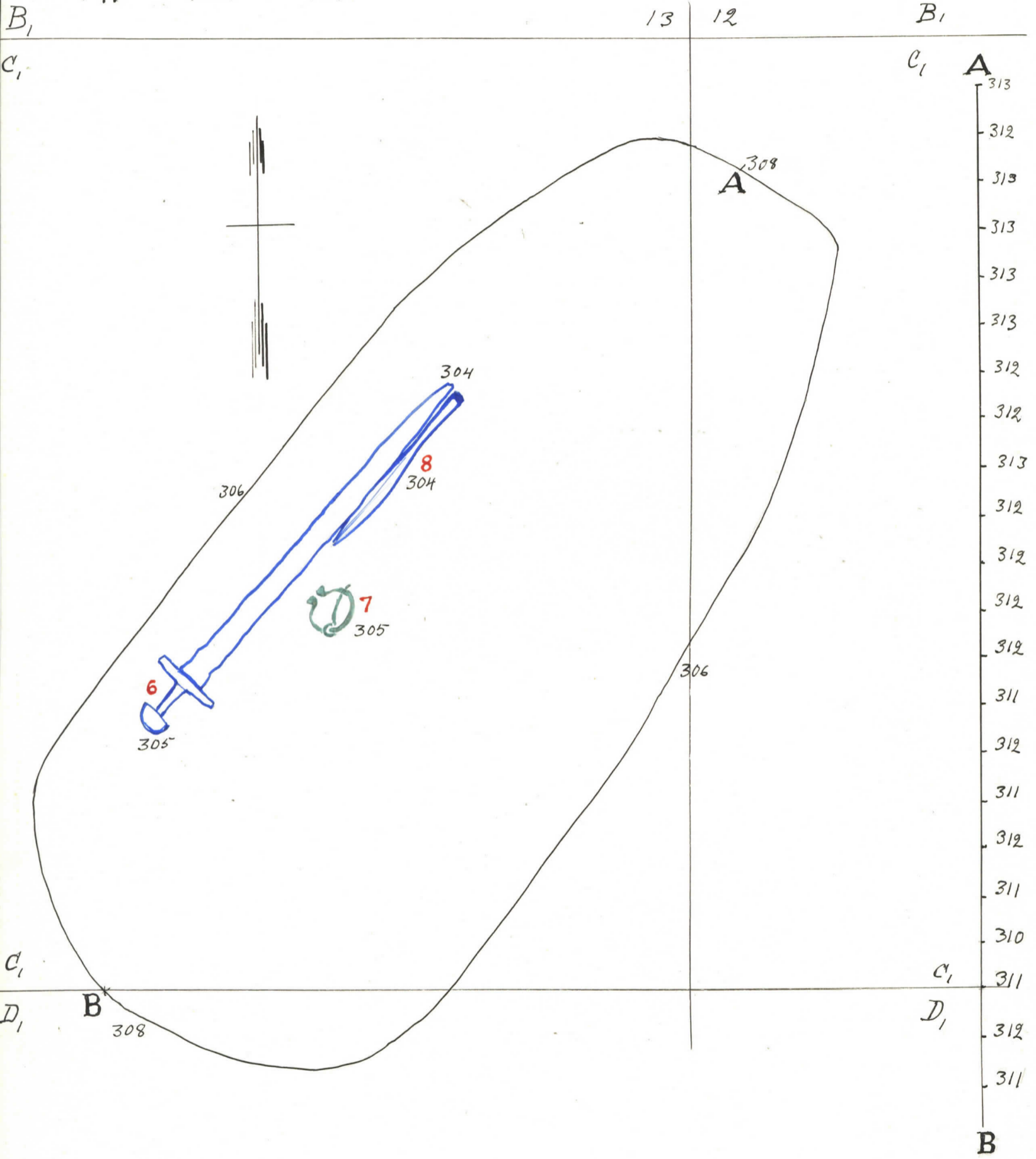

I raja
 II " "
 III " "

YLÄNE, ANIVEHMAANMÄKI

HAUTA L,
 A-L HIRVILUOTO 1957
 piirt. P. Huovari
 1:10

14196: 78	1	pronssia	268
: 79	2	saviast. pl.	283
: 80	3	" "	280
: 81	4	pr. kierukka	292
: 82	5	" "	297

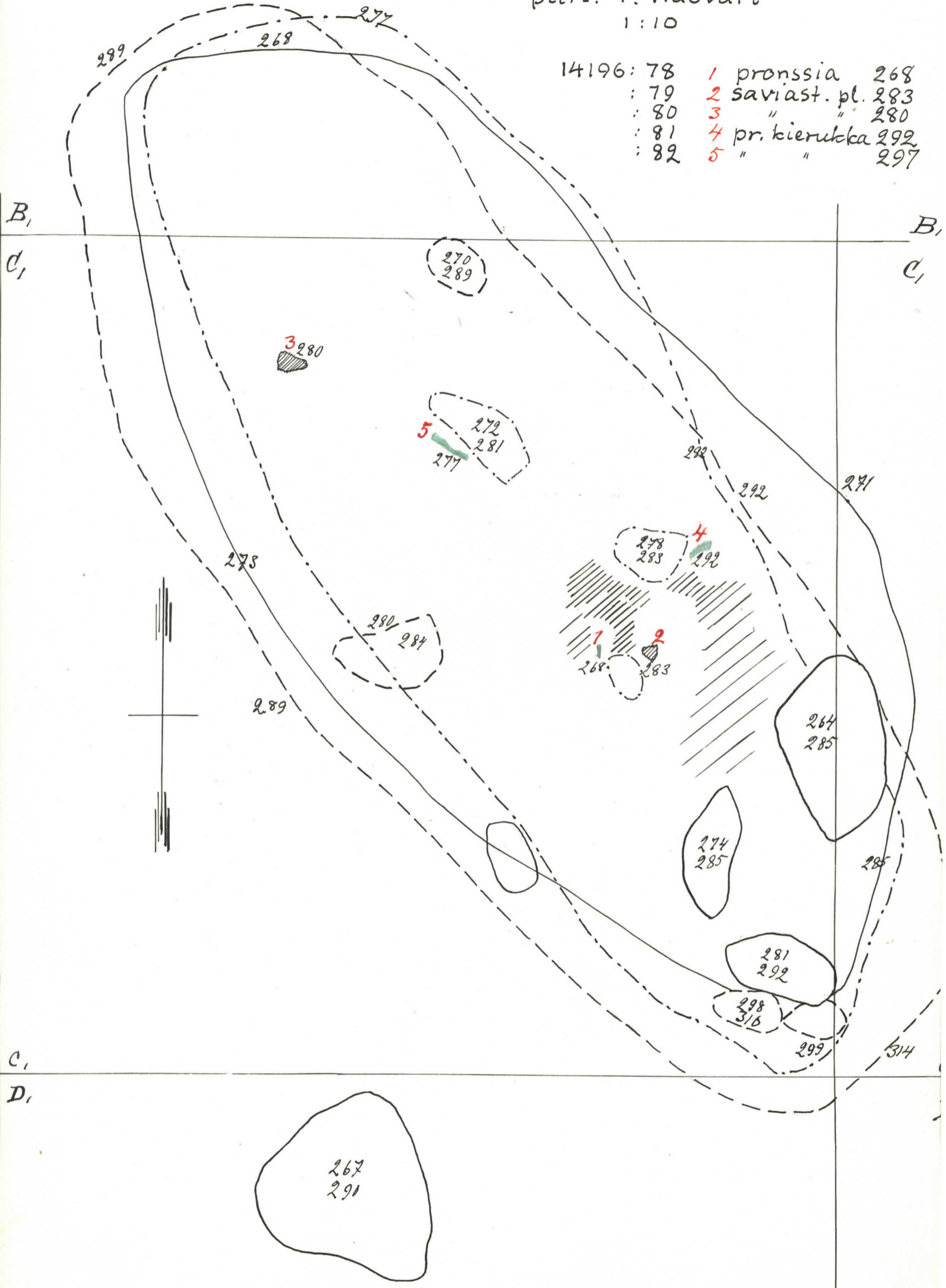

YLÄNE, ANIVEHMAANMÄKI

HAUTA L₂

A-LHIRVILUOTO 1957

piirt. P. Huovari

1:10

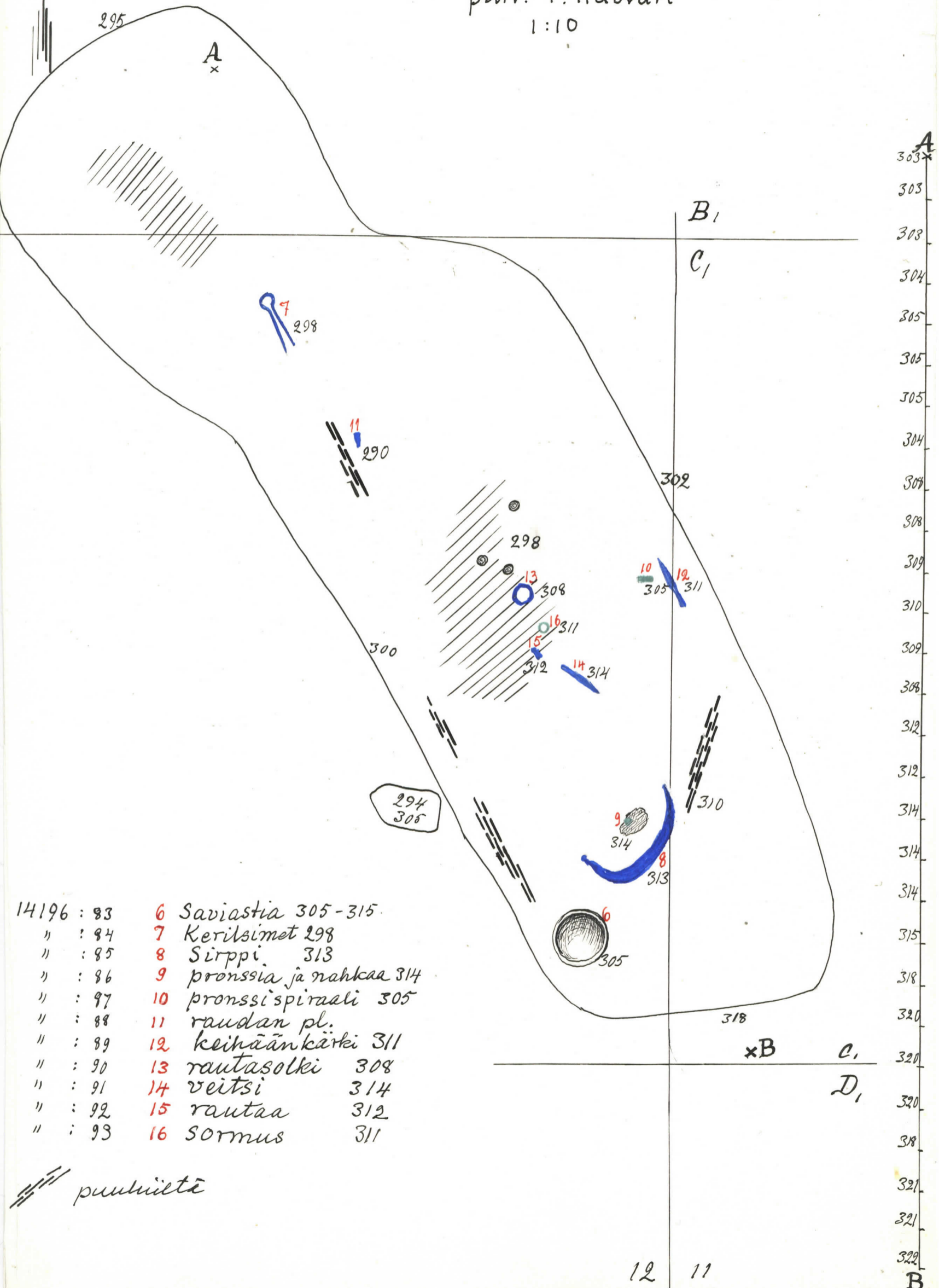

- | | |
|------------|--------------------------|
| 14196 : 83 | 6 Saviastia 305-315. |
| " : 84 | 7 Keräsimet 298 |
| " : 85 | 8 Sirppi 313 |
| " : 86 | 9 pronssia ja nahkaa 314 |
| " : 97 | 10 pronssi spiraali 305 |
| " : 88 | 11 raudan pl. |
| " : 89 | 12 keihäänkärki 311 |
| " : 90 | 13 rautasolki 308 |
| " : 91 | 14 veitsi 314 |
| " : 92 | 15 rautaa 312 |
| " : 93 | 16 sormus 311 |

puunviivä

12 11

A
303*
303
308
304
305
305
305
304
304
302
308
309
310
309
308
312
312
314
314
314
315
318
320
320
320
318
321
321
322
B

YLÄNE, ANIVEHMAANMÄKI

HAUTA II:2

A-L HIRVILUOTO 1957

piirt, Helinä Hautala

1:10

A

- I raja
- - - II " "
- · - · - III " "

3 sormus 221

14196:97

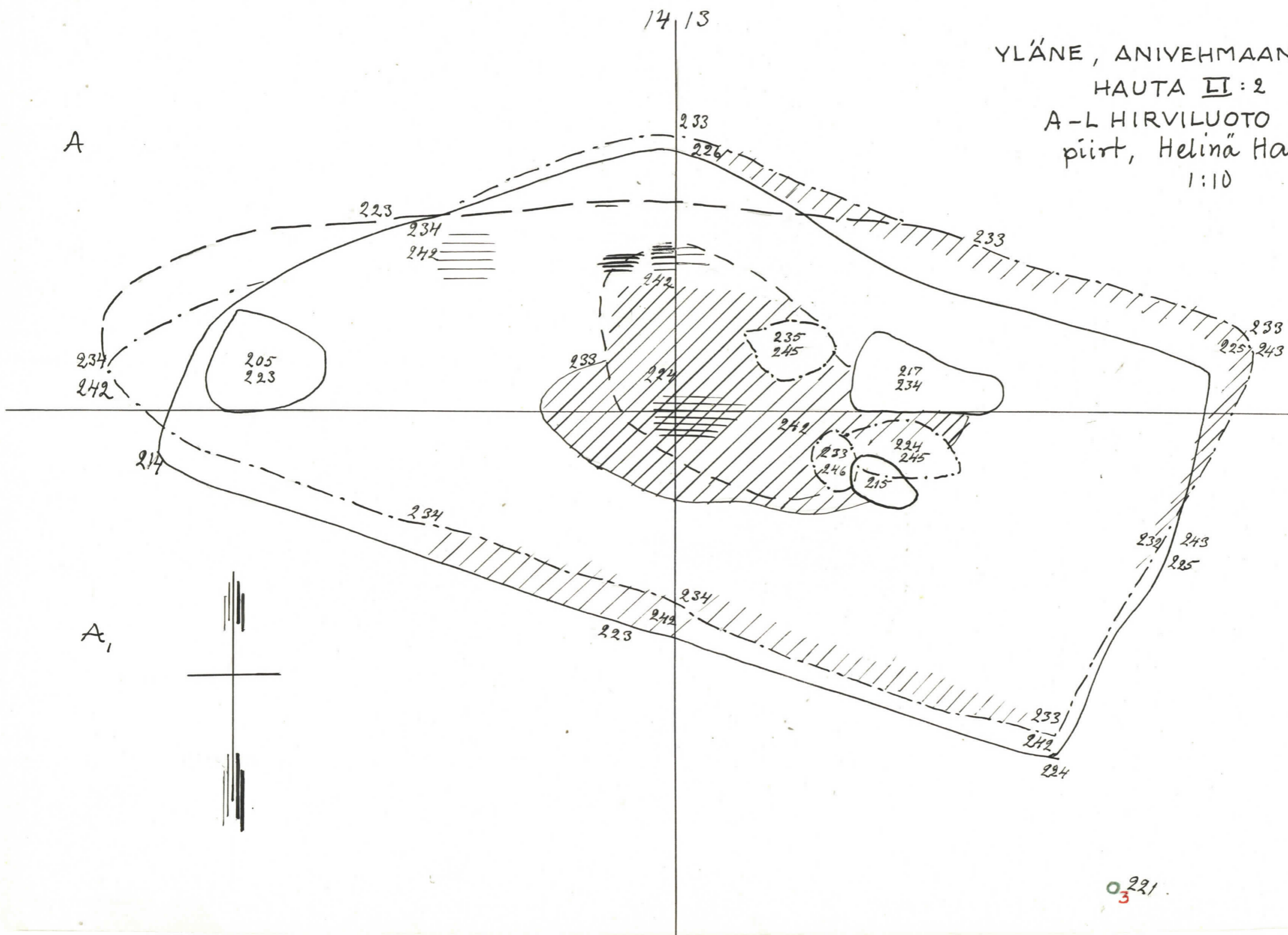

3 221

YLÄNE, ANIVEHMAANMÄKI
 HAUTA LI:3
 A-LHIRVILUOTO 1957
 piirt. Helinä Hautala
 1:10

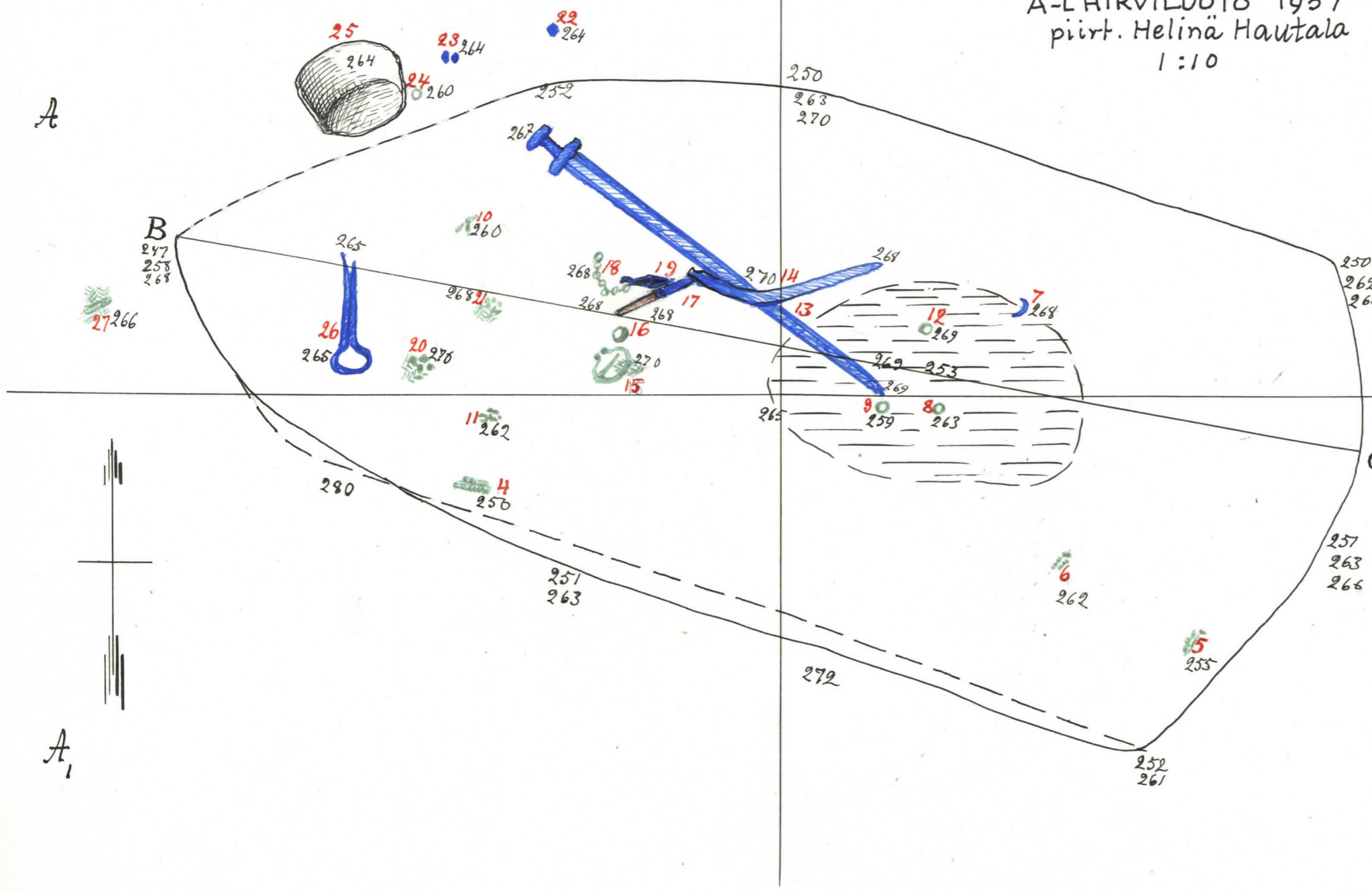

- | | | | |
|----------|----|--------------------------------|---------|
| 14196:98 | 4 | pronssispiraalia | 250 |
| :99 | 5 | " " | 225 |
| :100 | 6 | " " | 262 |
| :101 | 7 | rautaa | 268 |
| :102 | 8 | sormus | 263 |
| :103 | 9 | sormus | 259 |
| :104 | 10 | pronssispiraalia | 260 |
| :105 | 11 | " " | 262 |
| :106 | 12 | Sormus | 269 |
| :107 | 13 | miekka | 267-269 |
| :108 | 14 | viekate | 268 |
| :109 | 15 | solki | 270 |
| :111 | 16 | sormus | 268 |
| :113 | 17 | puukko | 268 |
| :118 | 18 | ketjua | 269 |
| :115 | 19 | rautaa | 269 |
| :119 | 20 | tekstiiliä ja pronssia | 270 |
| :120 | 21 | tekstiiliä ja pronssia | 268 |
| :121 | 22 | rautaa | 264 |
| :122 | 23 | 2 rautapalaa | 264 |
| :123 | 24 | meripihkaripus | 260 |
| :124 | 25 | saviastian puolikas | 264 |
| :125 | 26 | keritsimet | 265 |
| :126 | 27 | pronssispiraalia ja tekstiiliä | 266 |

≡≡≡ noki maata

B 275 274 273 274 274 276 276 275 275 274 274 273 274 274 273 272 272 271 270 270 269 267 268 266 266 C

YLÄNE, ANIVEHMAANMÄKI
 HAUDAT II ja III
 A-L HIRVILUOTO 1957
 piirt. P. Huovari
 1:10

13

12

Karttaliite 18

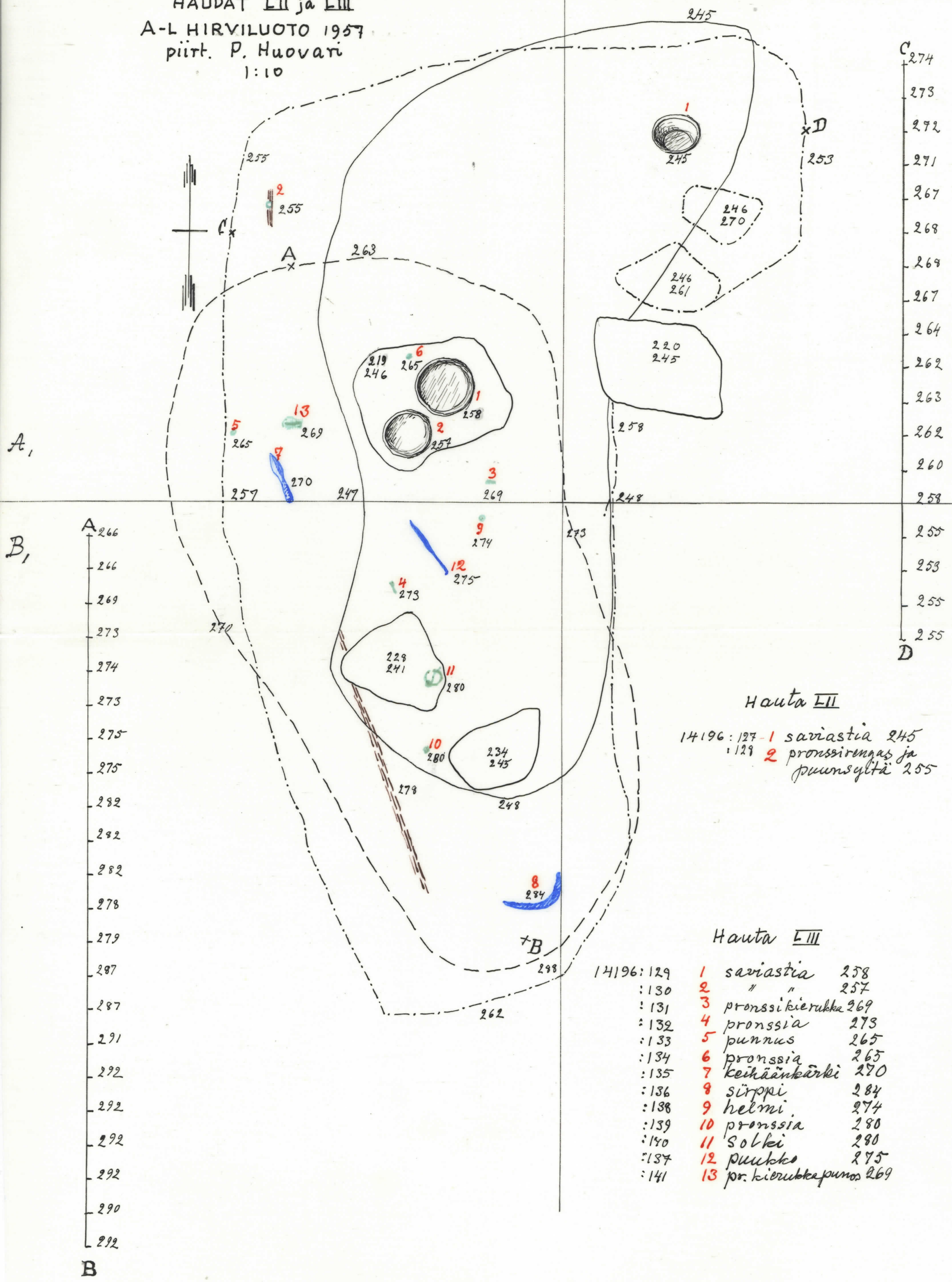

C
 274
 273
 272
 271
 267
 268
 269
 267
 264
 262
 263
 262
 260
 258
 255
 253
 255
 D

Hauta II

14196:127-1 saviastia 245
 :129 2 pronssirengas ja puunsyltä 255

Hauta III

- | | | | |
|-----------|----|---------------------|-----|
| 14196:129 | 1 | saviastia | 258 |
| :130 | 2 | " " | 257 |
| :131 | 3 | pronssikierukka | 269 |
| :132 | 4 | pronssia | 273 |
| :133 | 5 | punnus | 265 |
| :134 | 6 | pronssia | 265 |
| :135 | 7 | keihäänkärki | 270 |
| :136 | 8 | sirppi | 284 |
| :138 | 9 | helmi | 274 |
| :139 | 10 | pronssia | 280 |
| :140 | 11 | solki | 280 |
| :137 | 12 | puukko | 275 |
| :141 | 13 | pr. kierukke+punnus | 269 |

A
 266
 266
 269
 273
 274
 275
 275
 282
 282
 282
 278
 279
 287
 287
 291
 292
 292
 292
 292
 290
 292
 B

YLÄNE, ANIVEHMAANMÄKI

HAUTA LIV:1

A-L HIRVILUOTO 1957

piirt. H. Hautala

1:10

Karttaliite 19

14

15

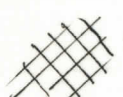
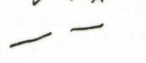
 nokea
 punaista maata
 tumman raja

A,

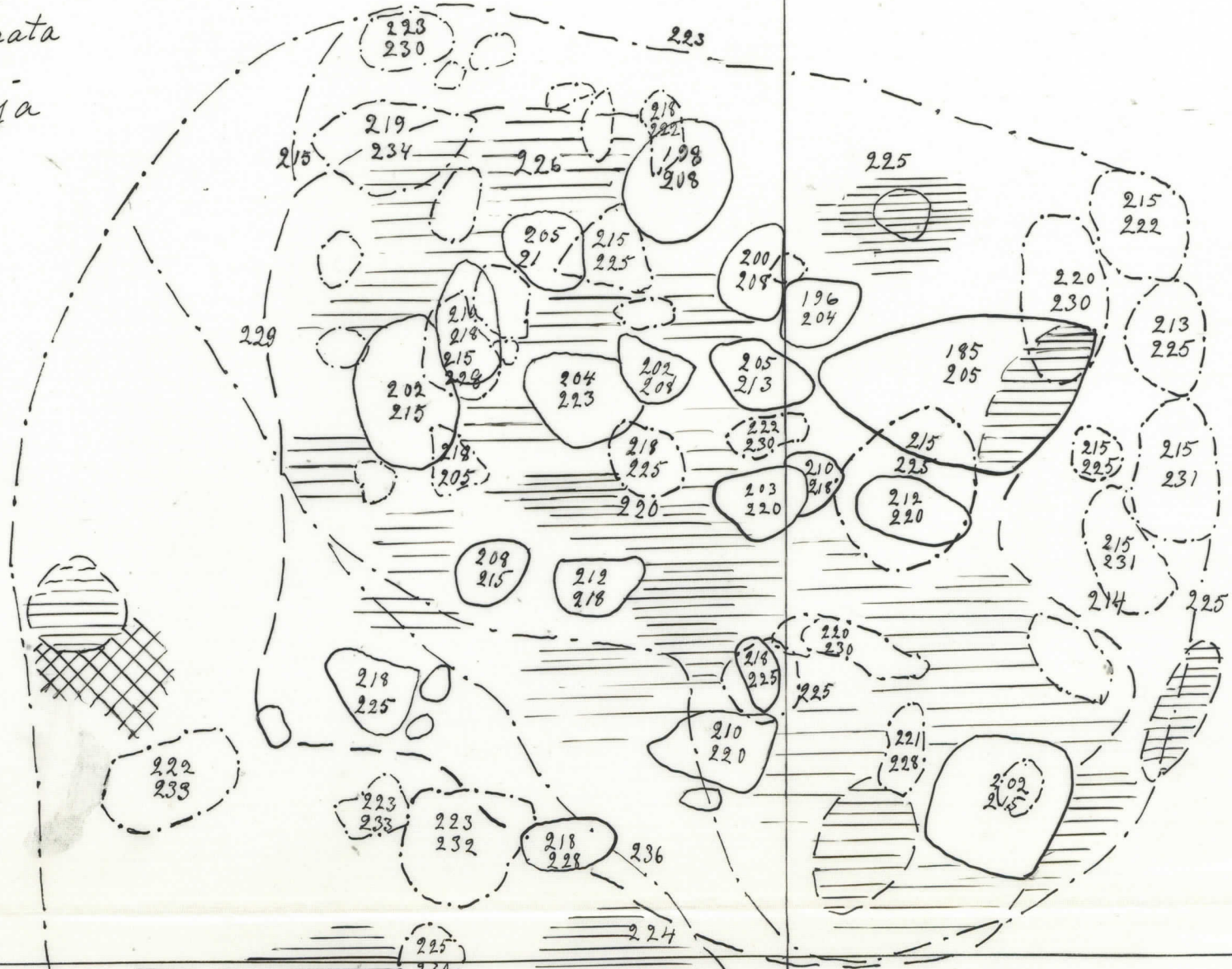
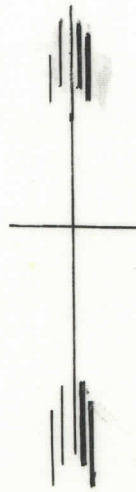

B,

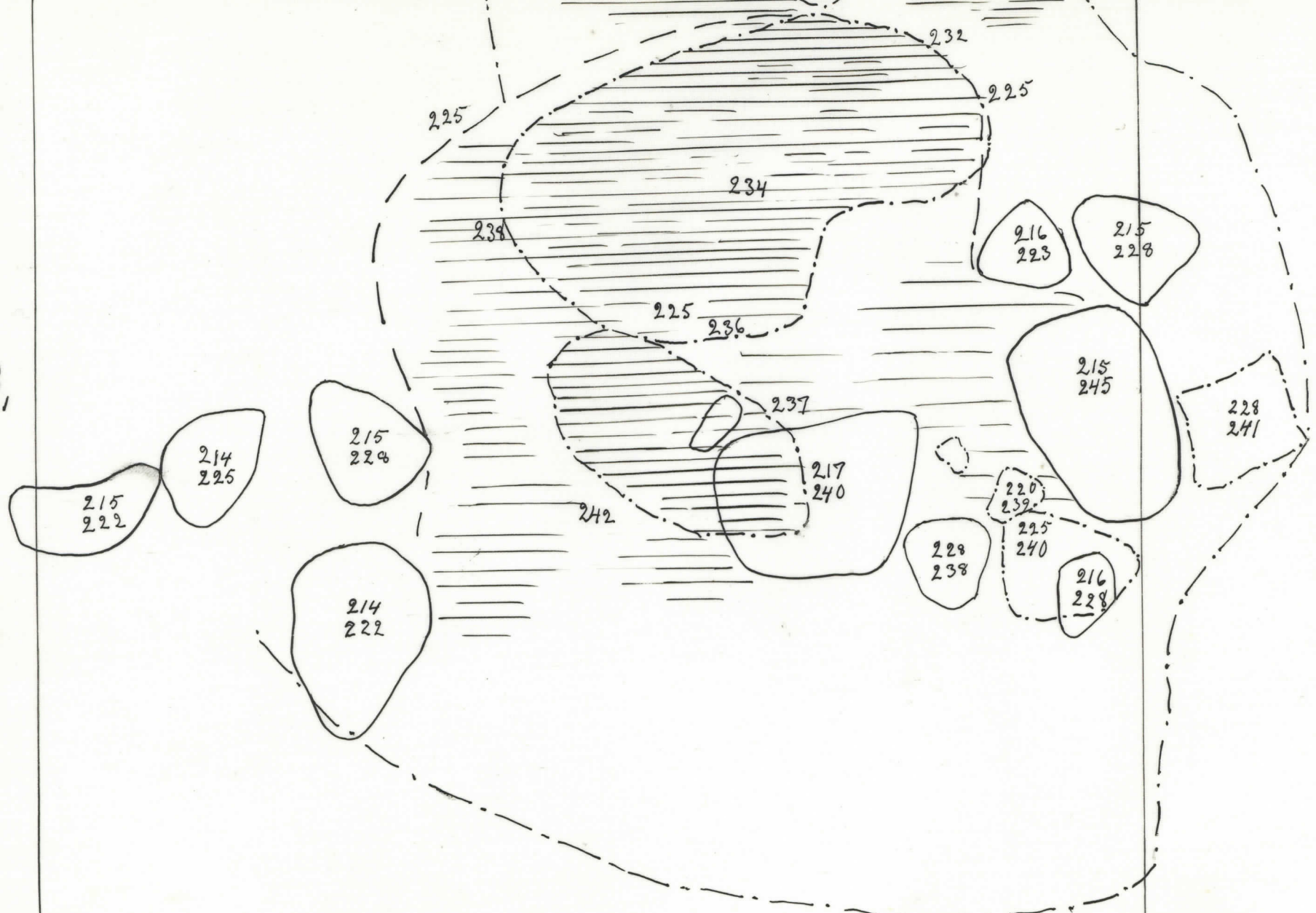

B,

YLÄNE, ANIVEHMAANMÄKI
H. LIV:3 Erikoiskartta A-B
A-L HIRVILUOTO 1957
piirt. Helinä Hautala

1:1

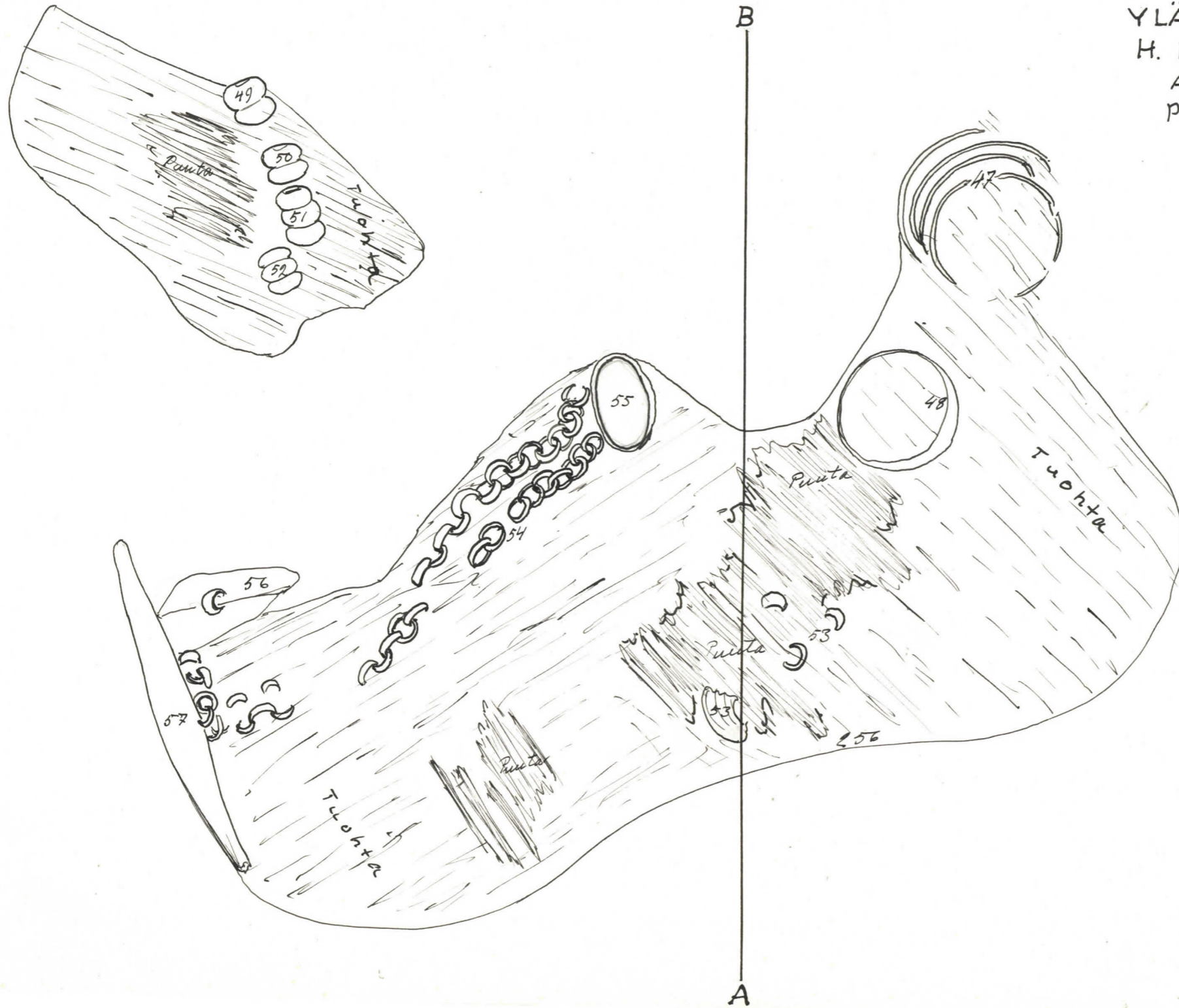

YLÄNE, ANIVEHMAANMÄKI
 HAUTA LVI
 A-L HIRVILUOTO 1957
 piirt. Helinä Hautala
 1:10

||||| tumma alue
 // ruskeita viivoja

14196:183	1	Saviastian pl.	248
:184	2	"	} 249
:185	3	"	
:186	4	"	
:187	5	"	} 253
:188	6	"	
:189	7	"	
:190	8	"	} 253
:191	9	"	
:192	10	"	
:193	11	Pronssia	253
:194	13	"	253
:195	14	Saviastian pl.	253
:196	15	"	} 253
:197	16	"	
:198	17	"	
:199	18	"	} 254
:200	19	"	
:201	20	"	
:202	22	Sirppi	259
:203	23	Pronssi + tekst.	259
:204	24	Saviast. pl.	259
:205	25	"	259
:206	26	"	254
:207	27	"	254
:208	36	Pronssi rengas	262
15	14		

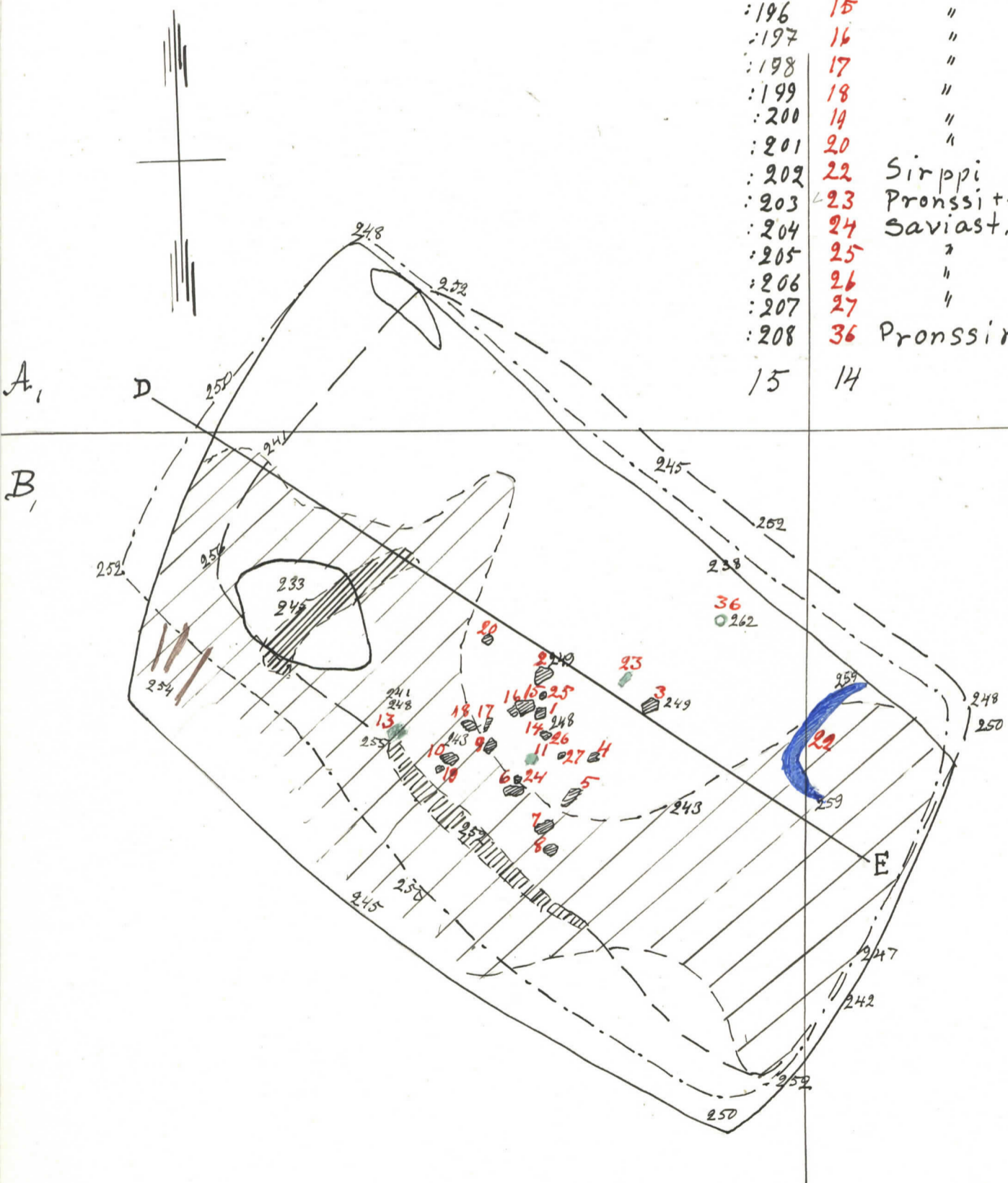

D 262 264 268 266 269 270 270 273 273 273 275 274 272 272 262 263 266 E

YLÄNE, ANIVEHMAANMÄKI
HAUTA LV:1

A-L HIRVILUOTO 1957
piirt. Pauli Huovi
1:10

B,
C,

16 15

B,
C,

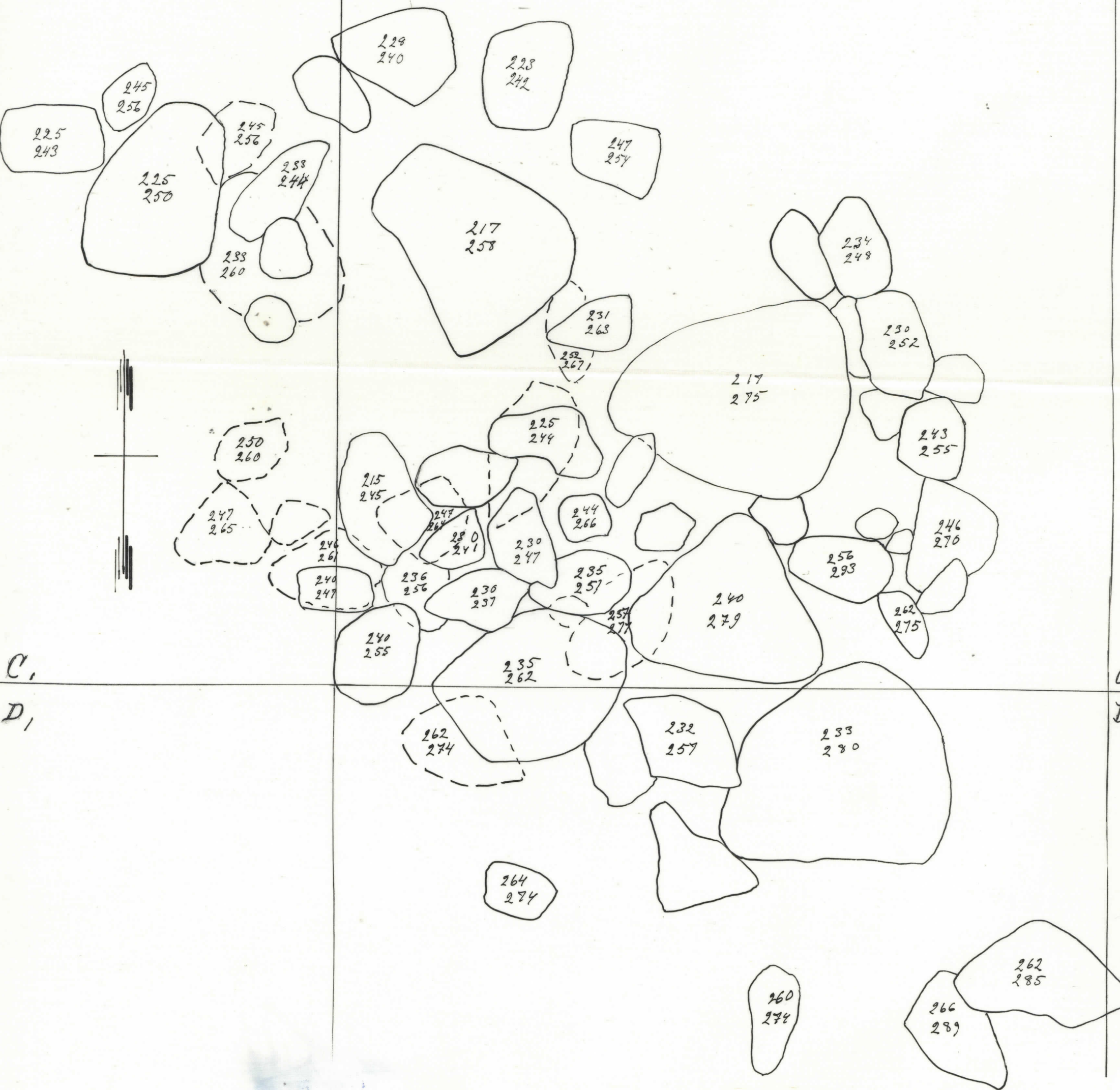

16 15

C,
D,

YLÄNE, ANIVEHMAANMÄKI
 HAUTA LV.2
 A-L HIRVILUOTO 1957
 piirt. Paavo Huovari
 1:10

14196:180	1	Rautanaula	308
:182	2	"	309
:183	3	keihäänkärki	324-326

—	I	raja
- - -	II	"
- · - · -	III	"
- - - - -	IV	"

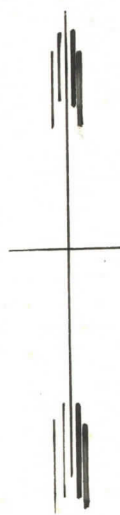
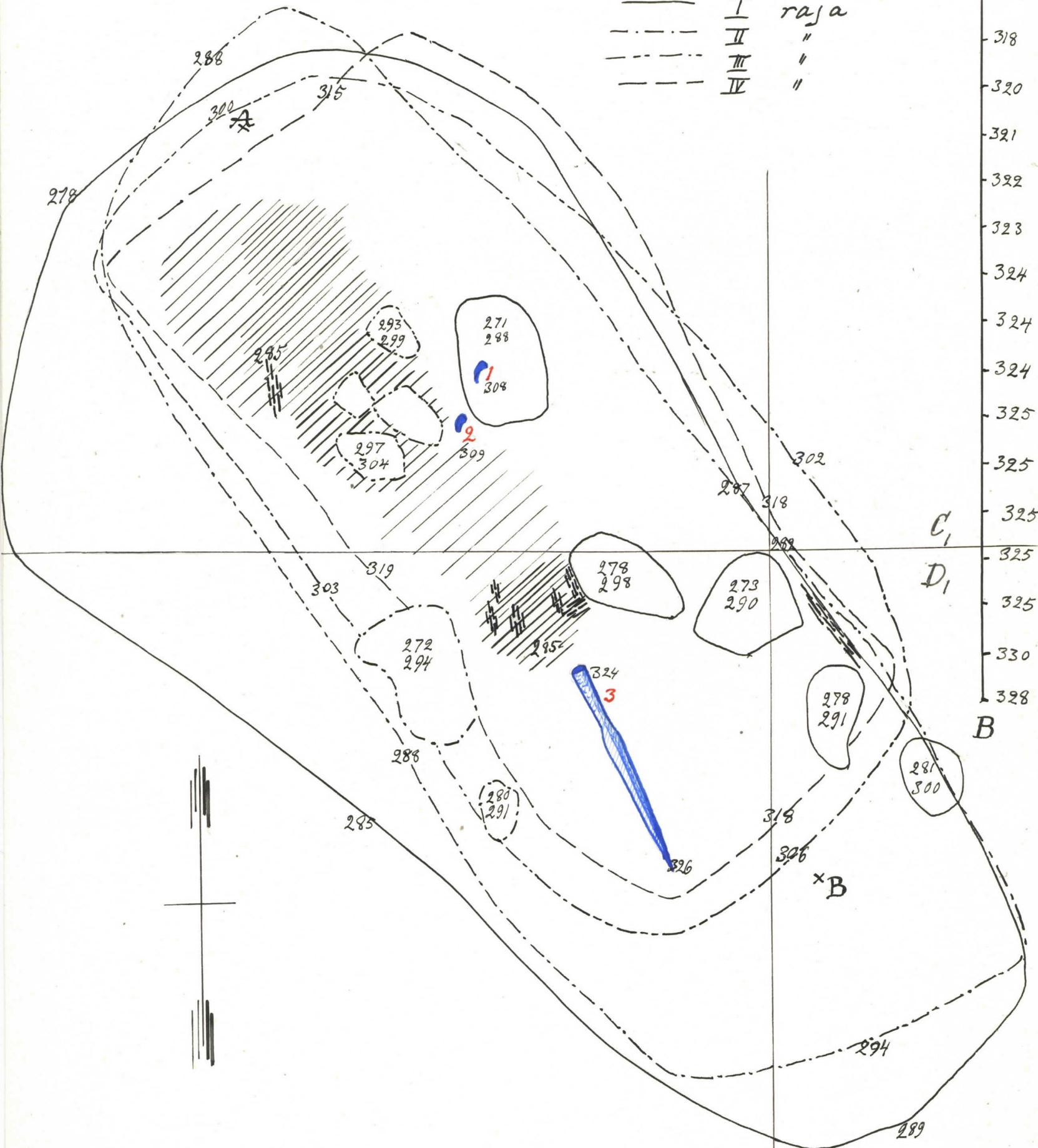
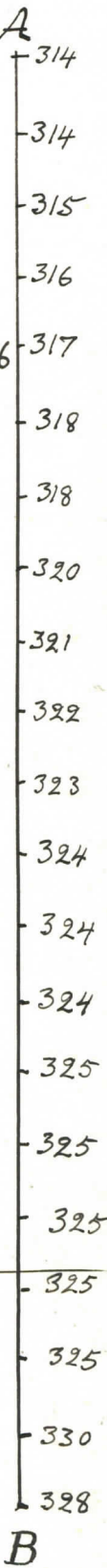

YLÄNE, ANIVEHMAANMÄKI
HAUTA LVII:1
A-LHIRVILUOTO 1957
piirt. Paavo Huovari

1:10

14196 : 209

1 keihäänkärki 341

C₁

C₁

D₁

A

340

341

343

345

345

347

346

346

345

344

342

341

341

339

339

338

337

336

336

335

335

334

B

D₁

E₁

302

B

D₁

E₁

303

325

341

316

15 14

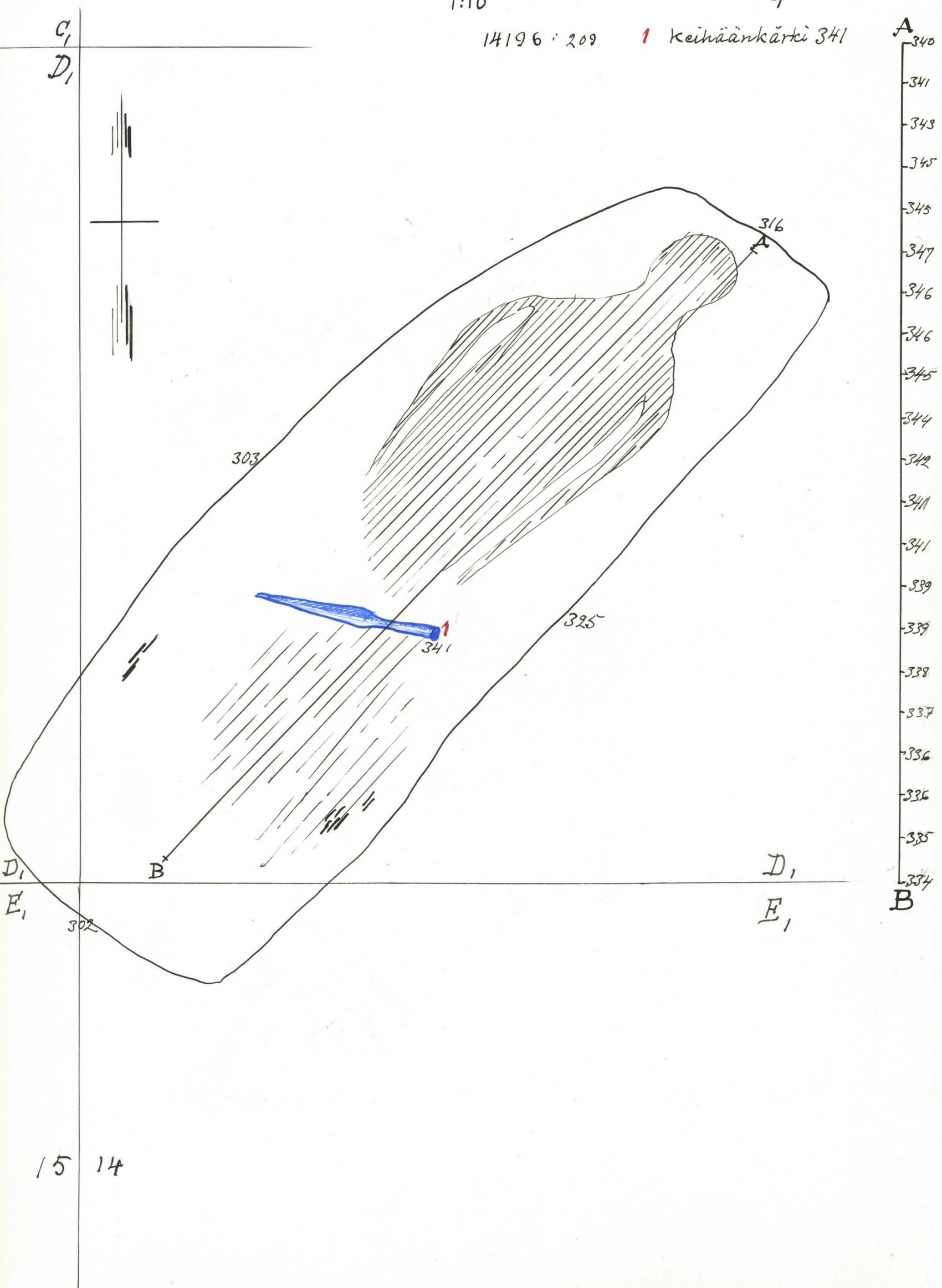

A

3 190

A

A₁

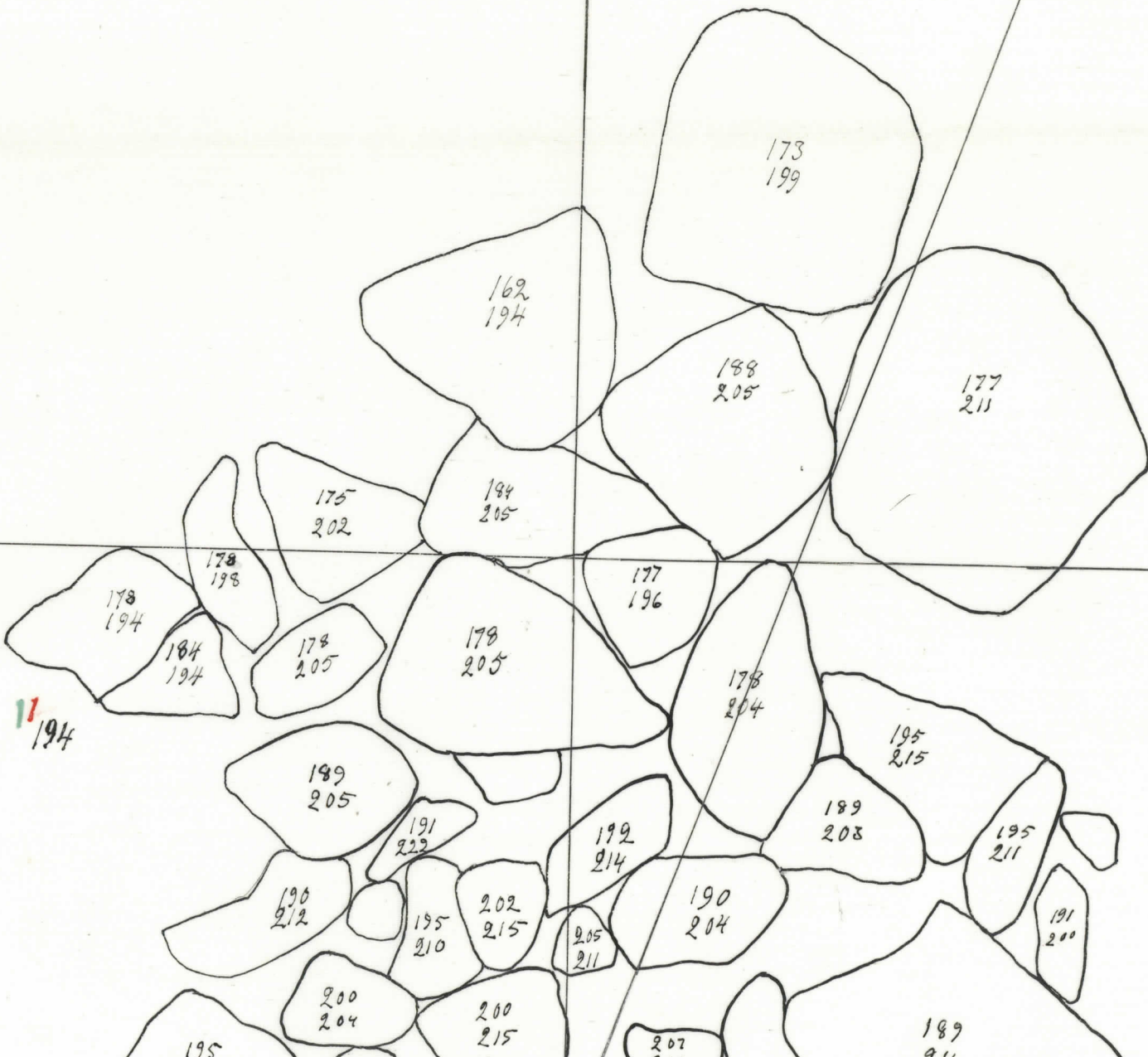

1 194

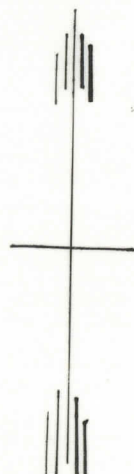

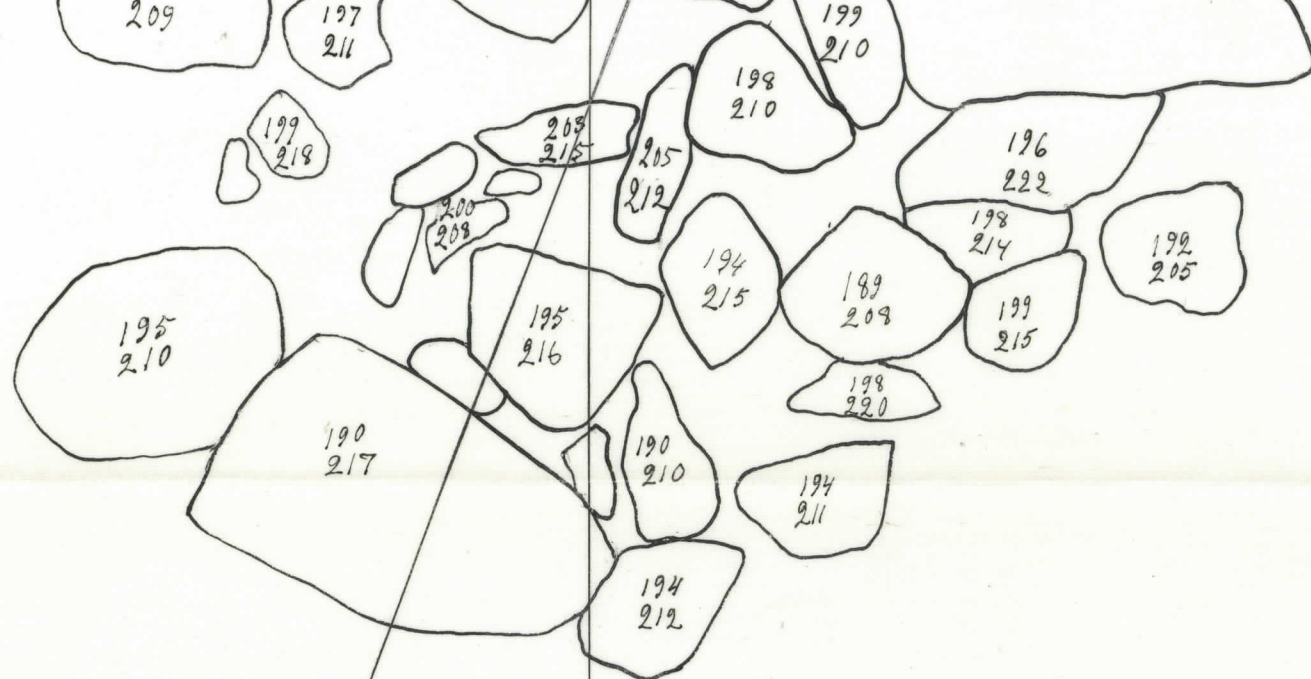

A,

B

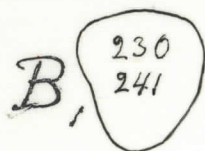

233

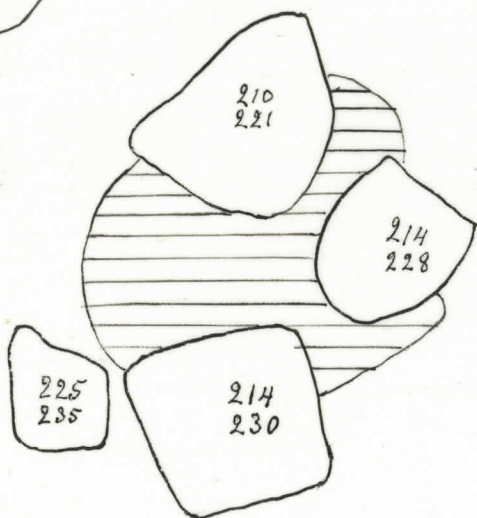

243

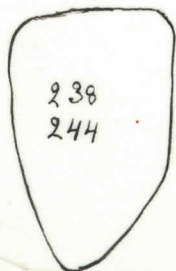

YLÄNE, ANIVEHMAANMÄKI
HAUTA LVIII: 31

A-LHIRVILUOTO 1957
piirt. Helinä Hautala

1:10

- | | | | |
|---|-----------|-----|-----------|
| 1 | Pronssia | 194 | 14196:210 |
| 2 | Kulkkunen | 187 | " : 211 |
| 3 | Yjön osa | 180 | " : 212 |

YLÄNE, ANIVEHMAANMÄKI
 HAUTA LVIII: 2
 A-L HIRVILUOTO 1957
 piirt. Helina Hautala
 1:10

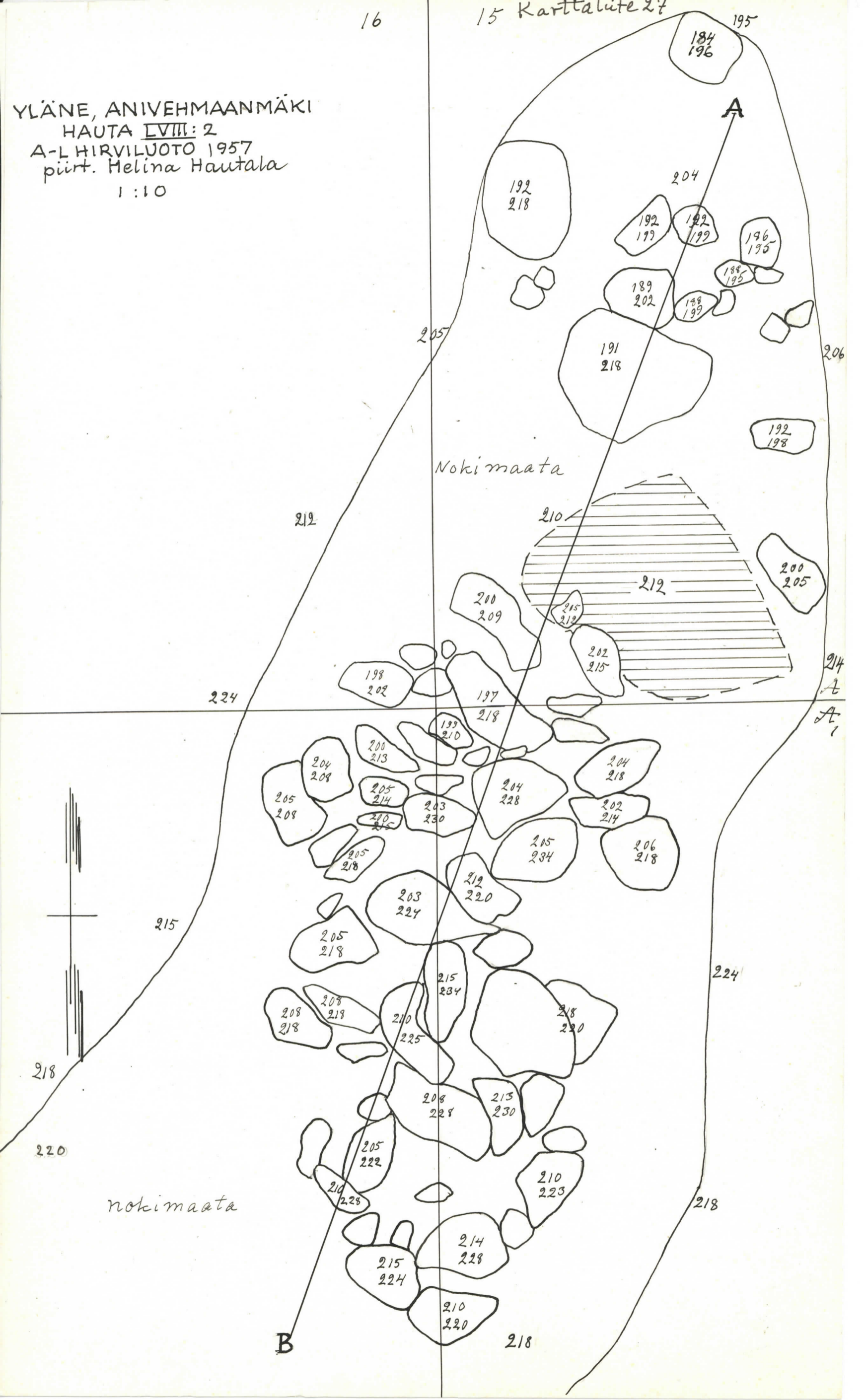

Nokimaata

nokimaata

B

A

214
A
A
1

16

15

Karttaliite 28

YLÄNE, ANIVEHMAANMÄKI
 HAUTA LVIII:3
 A-L HIRVILUOTO 1957
 piirt, Helinä Hautala
 1:10

- 4 Sormus 228 14196:213
- 5 Saviastian pala 228 : 214
- 6 Pronssipala 238 : 215

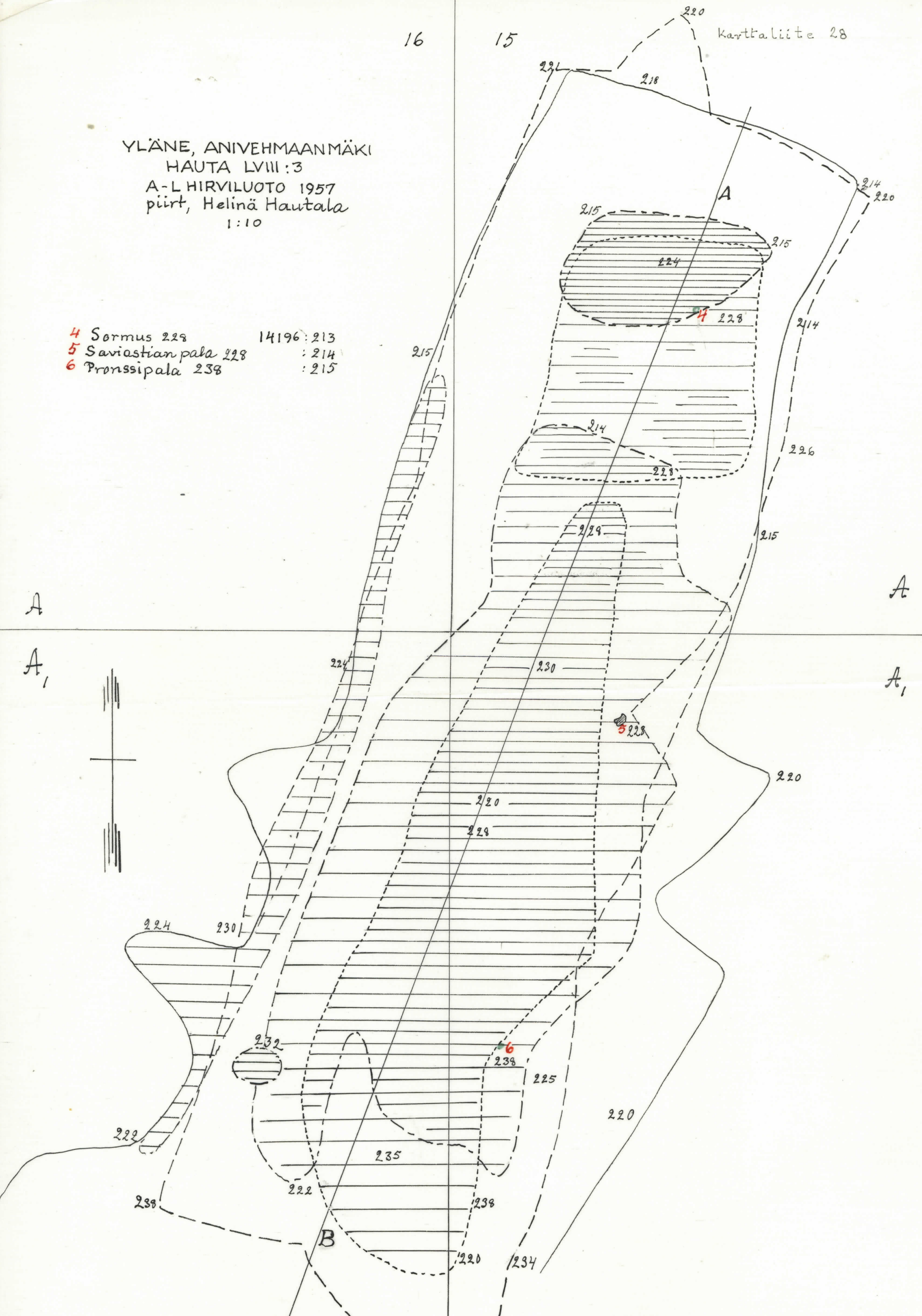

A

A'



A

A'

B

YLÄNE, ANIVEHMAANMÄKI
HAUTA LVIII:4
A-L HIRVILUOTO 1957
piirt. Helinä Hautala
1:10

- 7 Sininen kaksoishelmi 248 14196:216
- 8 Pronssispiraalia ja tekstiiliä 250
14196:217
- 9 Raudanpala 259 " :218

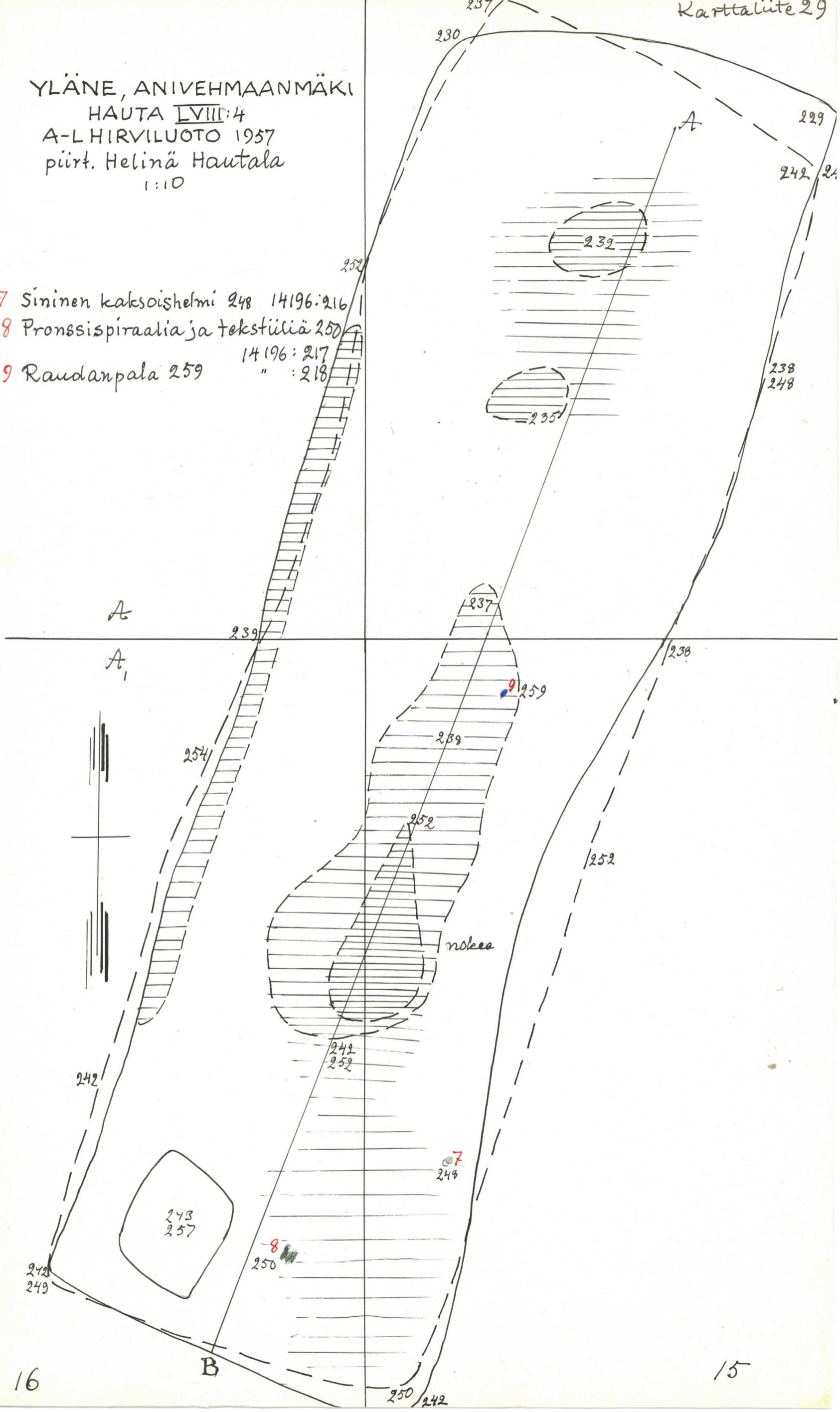

YLÄNE, ANIVEHMAANMÄKI HAUTA LVIII:5

A-L HIRVILUOTO 1957
Helinä Hautala
1:10

- 10 Pronssia 2.74 14196:219
- 11 Tukirauta 275 : 220
- 12 Niittinaula 268 : 221
- 13 Pronssinaula 270 : 222
- 14 Keihäänkärki 263 : 223
- 15 Puukko 265 : 224
- 16 Rautaa ja nahkaa 272 : 225
- 17 Hopearahan pala 274 : 226
- 18 Solki ja osa vyötä 273 : 227
- 19 Rautaa 276 : 228

A

A.

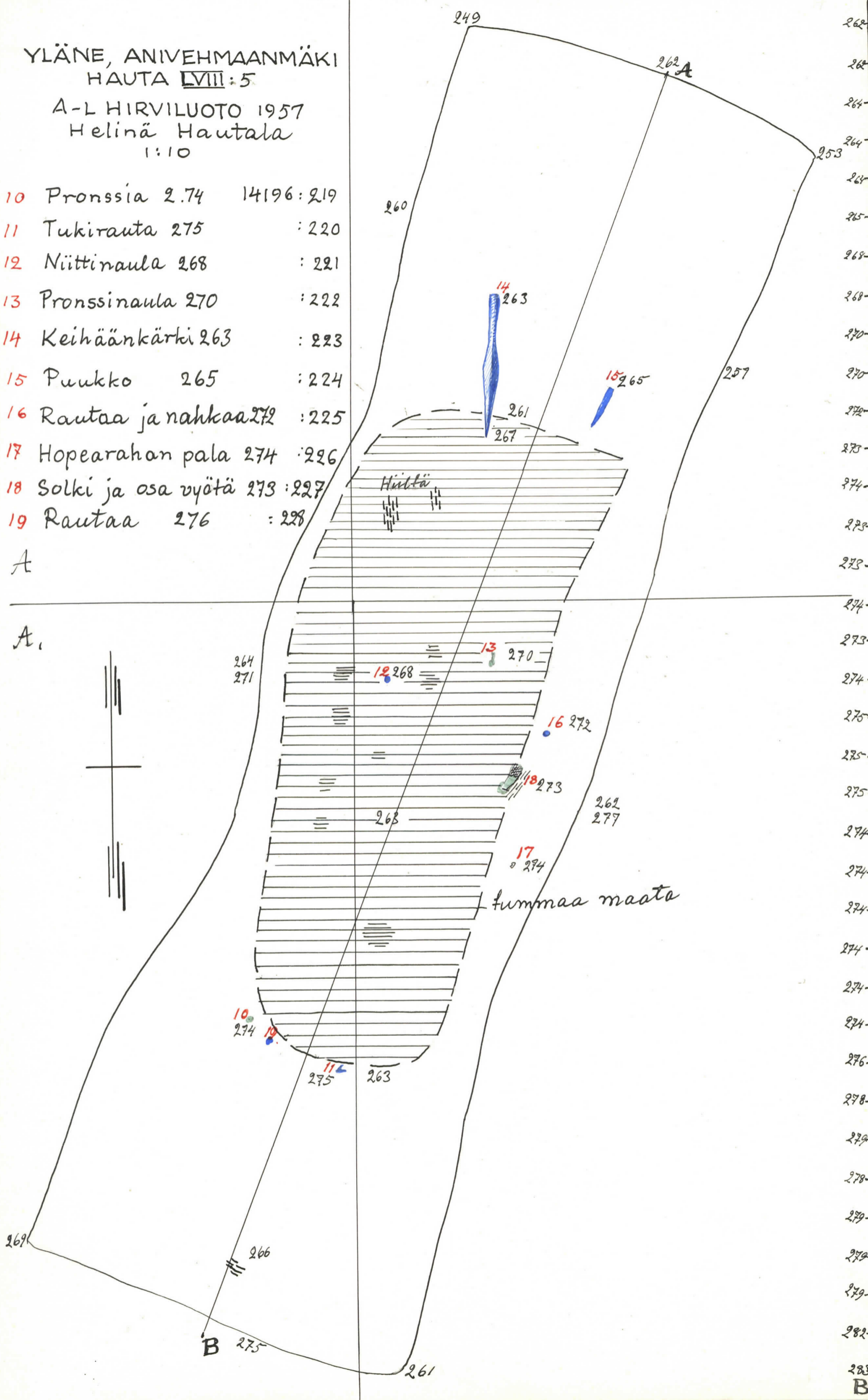

262
263
264
265
266
267
268
269
270
271
272
273
274
275
276
277
278
279
280
281
282
283

B

YLÄNE, ANIVEHMAANMÄKI
HAUTA LIX:1
A-L HIRVILUOTO 1957
piirt. Paavo Huovari
1:10

14196 : 231 I. Savinukunpala 265.

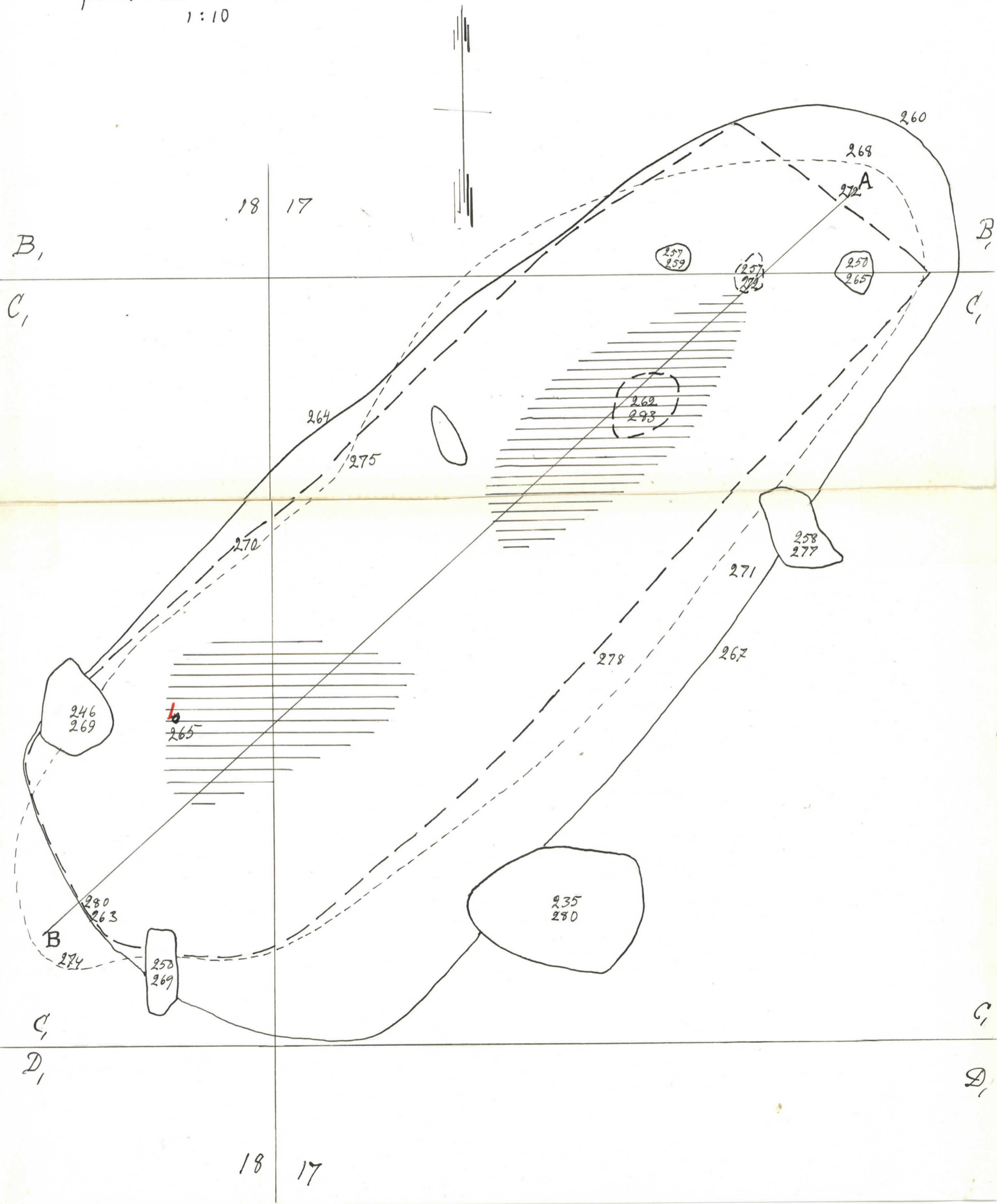

YLÄNE, ANIVEHMAANMÄKI

HAUTA IX:1

A-L HIRVILUOTO 1957
piirt. Paavo Huovari

1:10

14196 : 250 1. Helmen puolikas 277

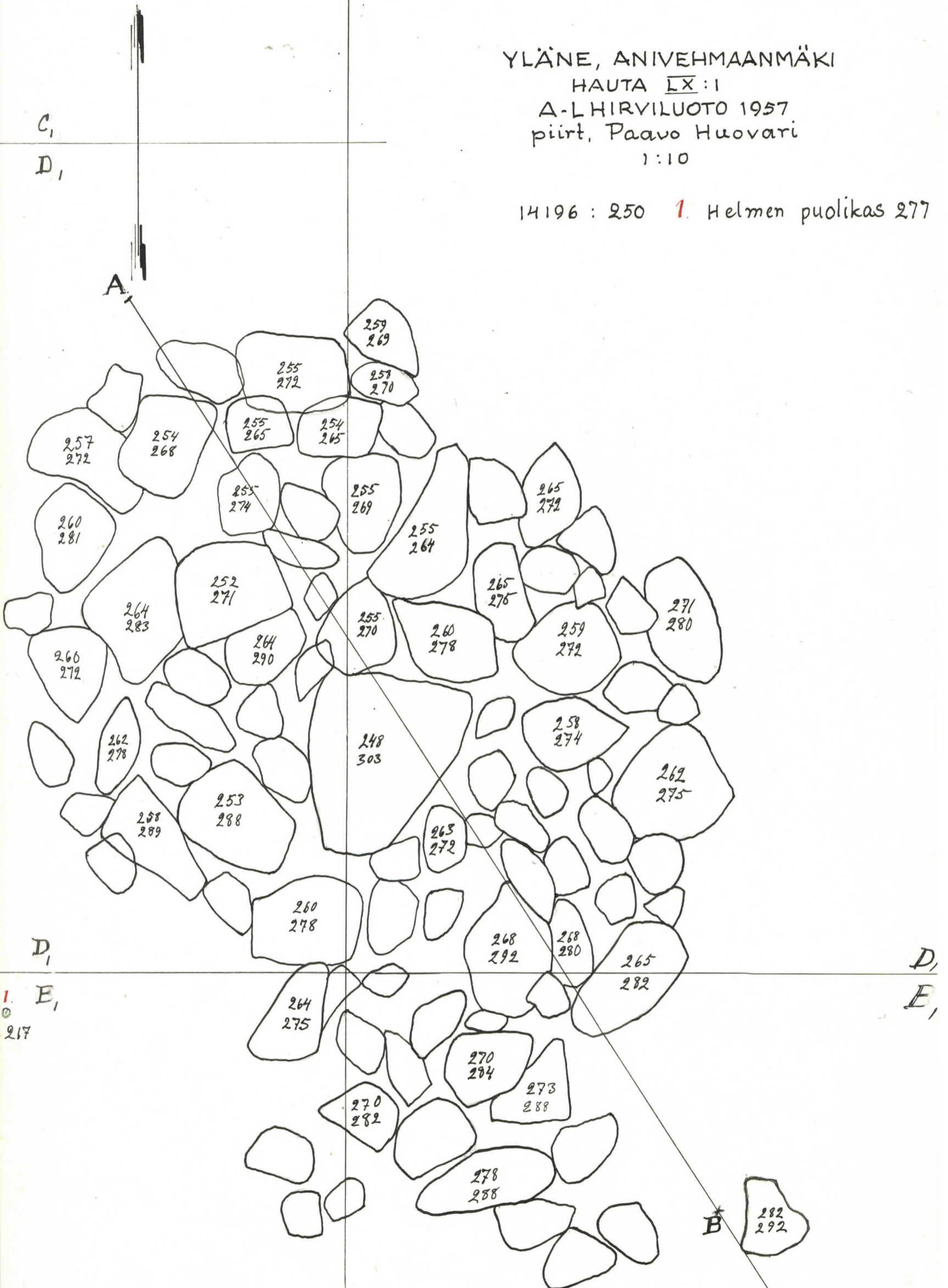

YLÄNE, ANIVEHMAANMÄKI

HAUTA IX: 2

A-LHIRVILUOTO 1957
piirt. Paavo Huovari

1:10

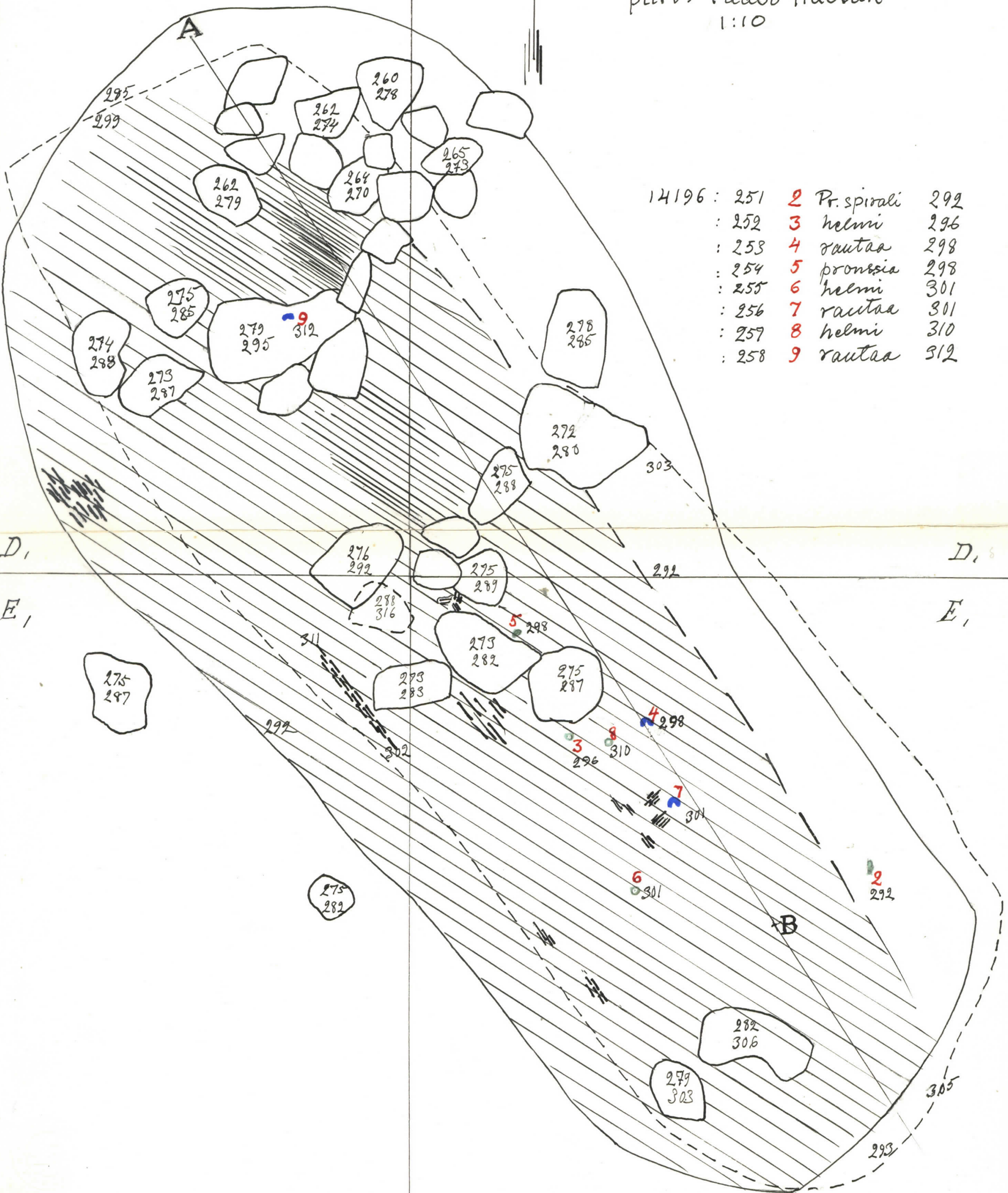

14196 :	251	2	Pr. spirali	299
:	252	3	helmi	296
:	253	4	rautaa	298
:	254	5	pronssia	298
:	255	6	helmi	301
:	256	7	rautaa	301
:	257	8	helmi	310
:	258	9	rautaa	312

D,

D,

E,

E,

YLÄNE, ANIVEHMAANMÄKI

HAUTA LX:3

A-L HIRVILUOTO 1957

piirt, Paavo Huovari

1:10

14196:259

10 helmi 317

:260

11 puukko 330

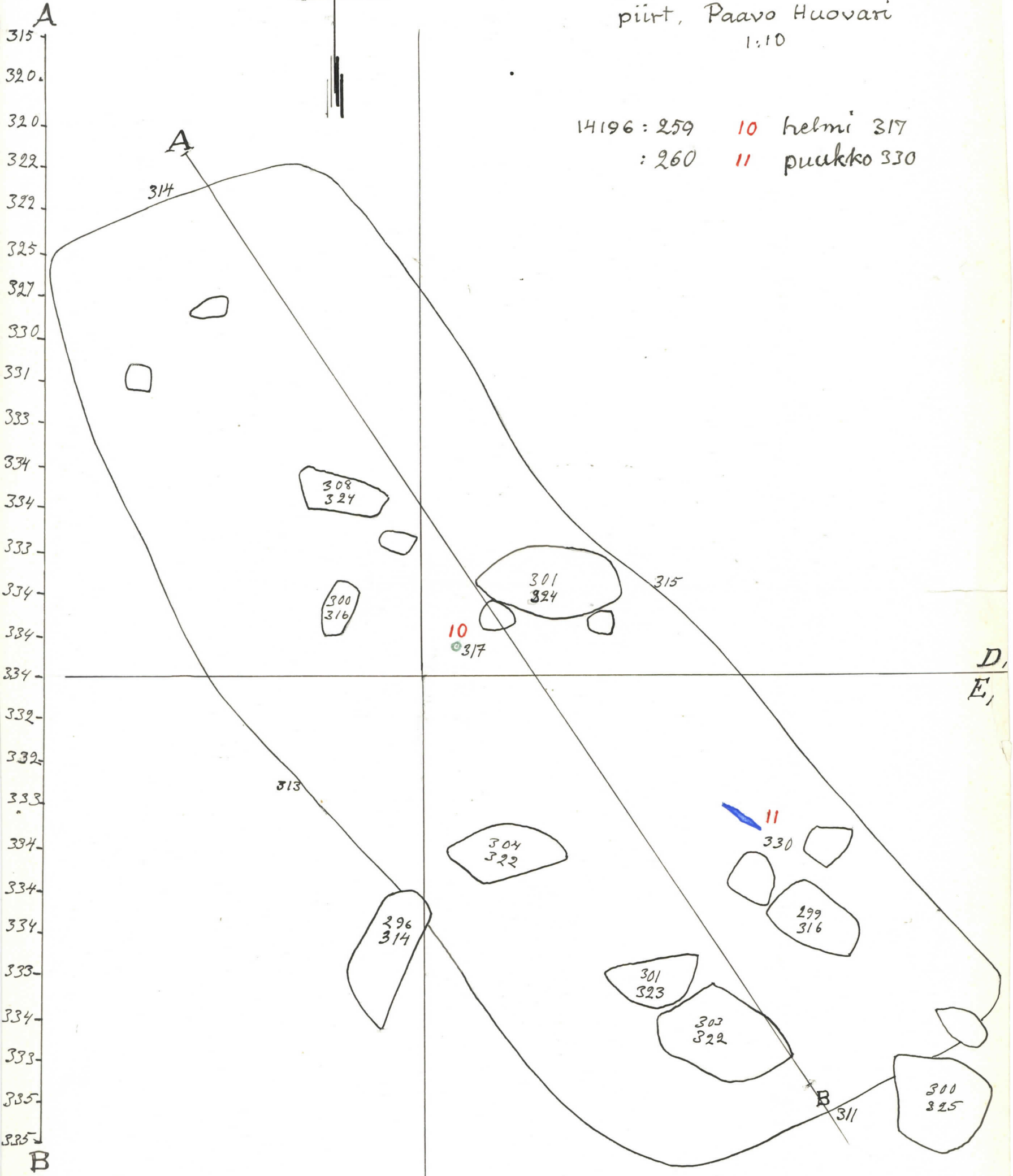

2m

I
B

Karttaliite 356

A

2m

YLÄNE, ANIVEHMAANMÄKI
 HAUTA LX, profiili
 A-L HIRVILUOTO 1957
 piirt L-1 Räsänen
 1:10

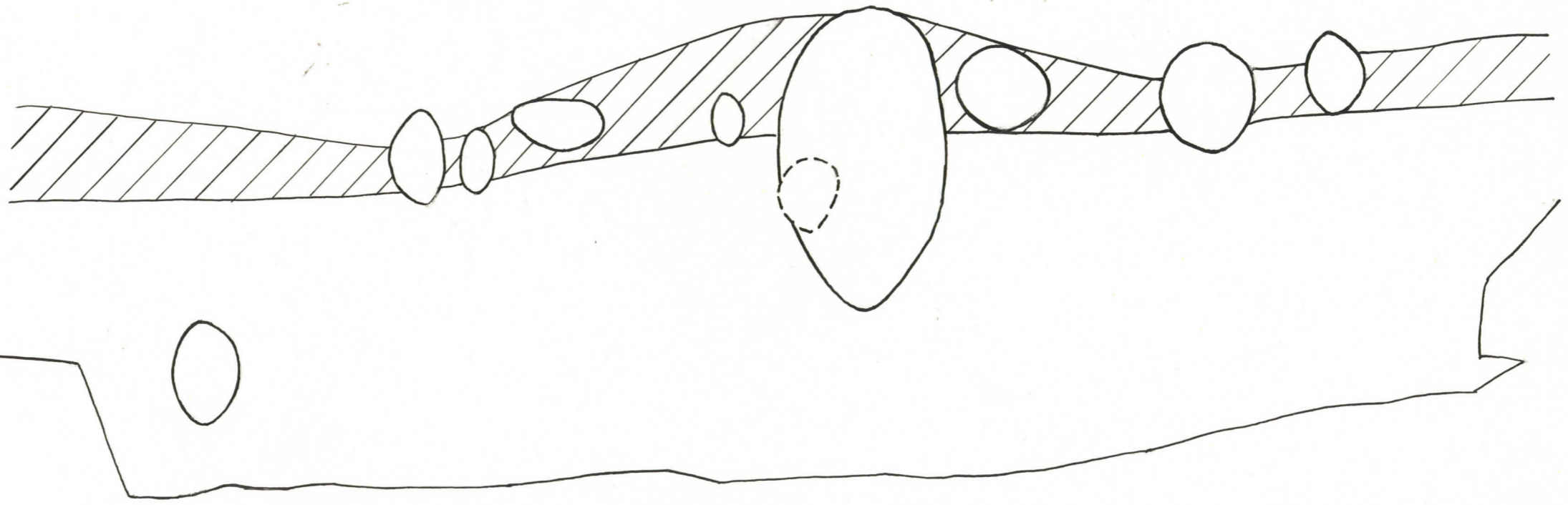

3m

3m

YLÄNE, ANIVEHMAANMÄKI
HAUTA LXI:1
A-L HIRVILUOTO 1957
piirt, Paavo Huovari
1:10

B,
C,

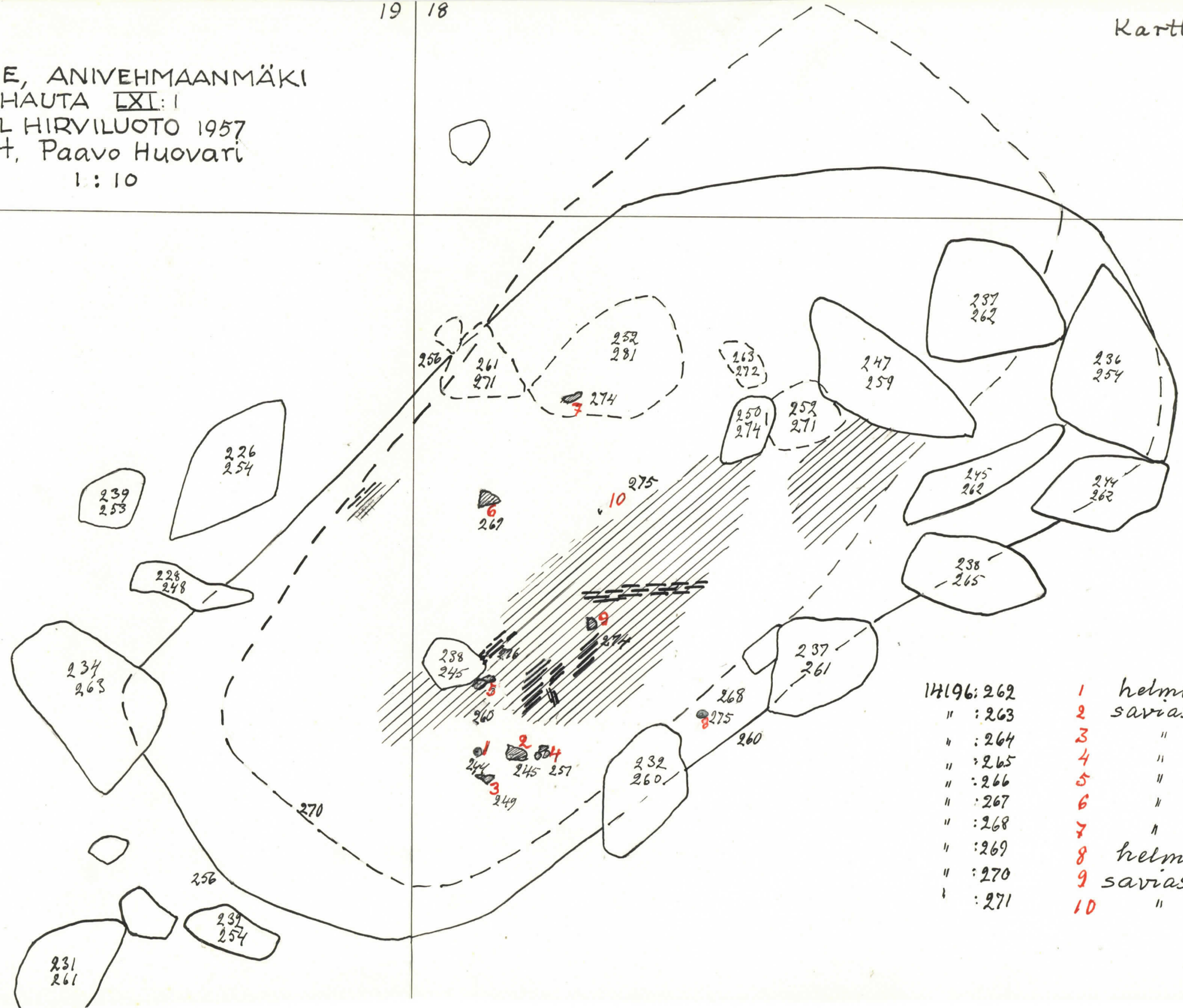

14196: 262	1	helmi	244
" : 263	2	saviastian pala	245
" : 264	3	"	249
" : 265	4	"	palasia 251
" : 266	5	"	" 260
" : 267	6	"	pala 269
" : 268	7	"	" 274
" : 269	8	helmi	275
" : 270	9	saviastian pala	274
" : 271	10	"	" 275

19 18

YLÄNE, ANIVEHMAANMÄKI

HAUTA LXI:2

A-L HIRVILUOTO 1957,
piirt. Paavo Huovari

1:10

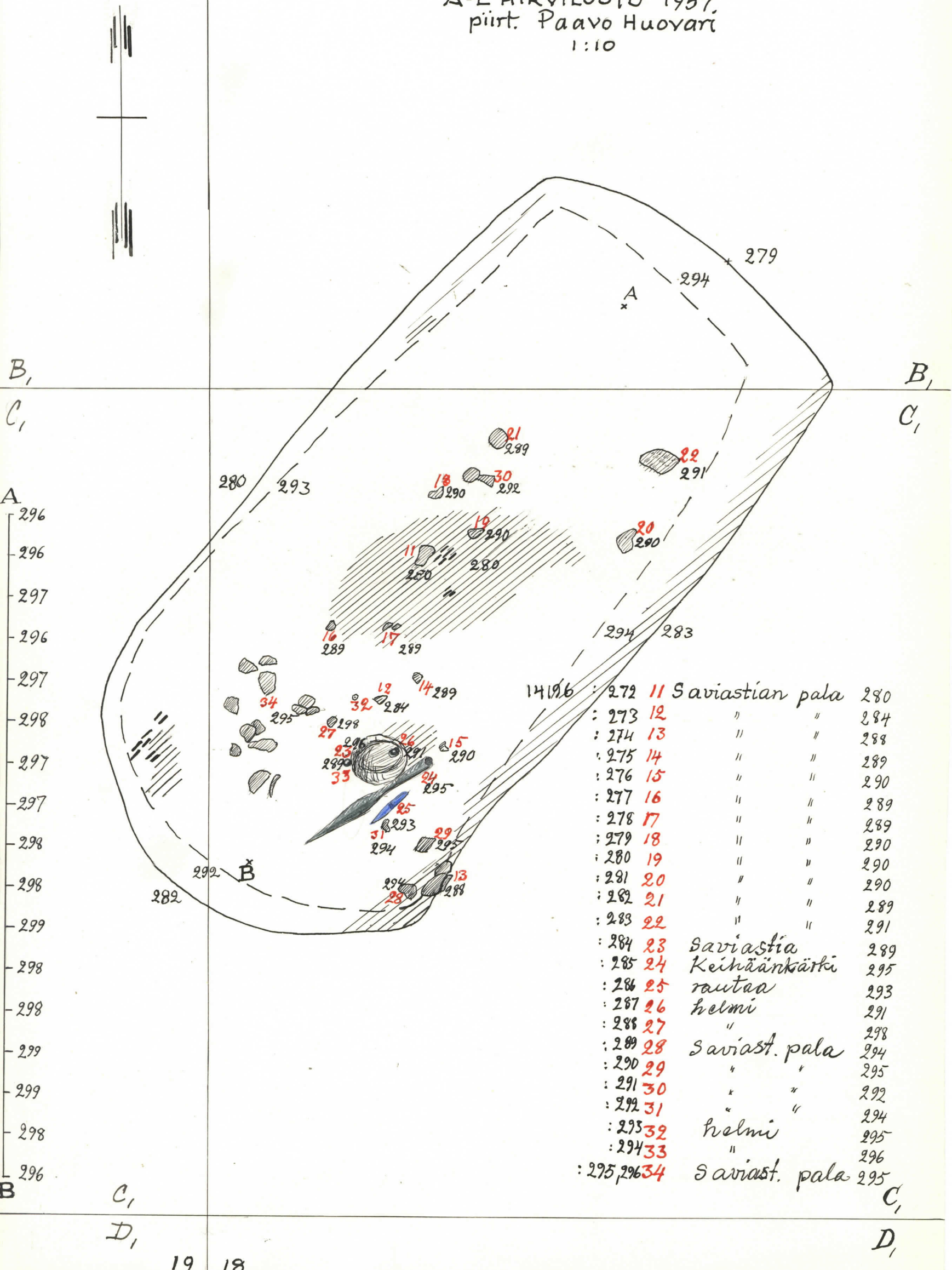

14196	: 272	11	Saviastian pala	280
	: 273	12	" "	284
	: 274	13	" "	288
	: 275	14	" "	289
	: 276	15	" "	290
	: 277	16	" "	289
	: 278	17	" "	289
	: 279	18	" "	290
	: 280	19	" "	290
	: 281	20	" "	290
	: 282	21	" "	289
	: 283	22	" "	291
	: 284	23	Saviastia	289
	: 285	24	Keihäänkärki	295
	: 286	25	rautaa	293
	: 287	26	helmi	291
	: 288	27	"	298
	: 289	28	Saviast. pala	294
	: 290	29	"	295
	: 291	30	"	292
	: 292	31	"	294
	: 293	32	helmi	295
	: 294	33	"	296
	: 295, 296	34	Saviast. pala	295

YLÄNE, ANIVEHMAANMÄKI

HAUTA LXII: 2

A-LHIRVILUOTO 1957
piirt. L-J Räsänen
1:10

235
236
232
232
240
240
242
242
244
244
245
247
248
248
248
247
248
248
248
247
248
248
248
247
248
248
248
247
246
246
246
246
245
245
245
245



- | | | | |
|------------------|----|-------------------------|-----------|
| 14196: 297 | 1 | sirppi | 231 - 242 |
| : 298 | 2 | saviastia | 244 |
| : 299 | 3 | rannerengas | 235 |
| : 300 | 4 | " | 235 |
| : 301 | 5 | " | 239 |
| : 302 | 6 | " | 239 |
| : 308 | 7 | kaularengas | 238 |
| : 311 | 8 | pr. (puukonneloja) | 239 |
| : 312 | 9 | puunsyitä (tuppi) | 239 |
| : 313 | 10 | sormus | 238 |
| : 315 | 11 | hampaat | 238 |
| : | 12 | liumassaa | 238 |
| : 316 | 13 | kupurasolki | 238 |
| : 818 | 14 | " | 238 |
| : 328 | 15 | helmi | 236 |
| : 329 | 16 | " | 238 |
| : 330 | 17 | " | 238 |
| : 339 | 18 | " | 238 |
| : " 19 | " | " | 238 |
| : 321 | 20 | kupurasolki | 238 |
| : 333 | 21 | pr. kierukoita | 235 |
| : 334 | 22 | " | 234 |
| : 335 | 23 | " | 235 |
| : 357 | 24 | pr. rengas | 237 |
| : 324 | 26 | pr. ketjua | 238 |
| : 338 | 27 | helmi ketju(ul) | 238 |
| : 339 | 28 | " " (sis.) | 238 |
| : 340 | 29 | tekstiili | 238 |
| : 341 | 30 | liumassaa | 239 |
| Karllal. 40: 342 | 31 | luuta (kaular. sis) | 238 |
| " : 343 | 32 | nahkaa (kaular. päällä) | 239 |
| " : 33 | 33 | nahkaa | 239 |
| : 344 | 34 | helmiä (4 kpl) | 238 |

YLÄNE, ANIVEHMAANMÄKI

HAUTA LXII:n Profiili

A-L HIRVILUOTO 1957

1:10

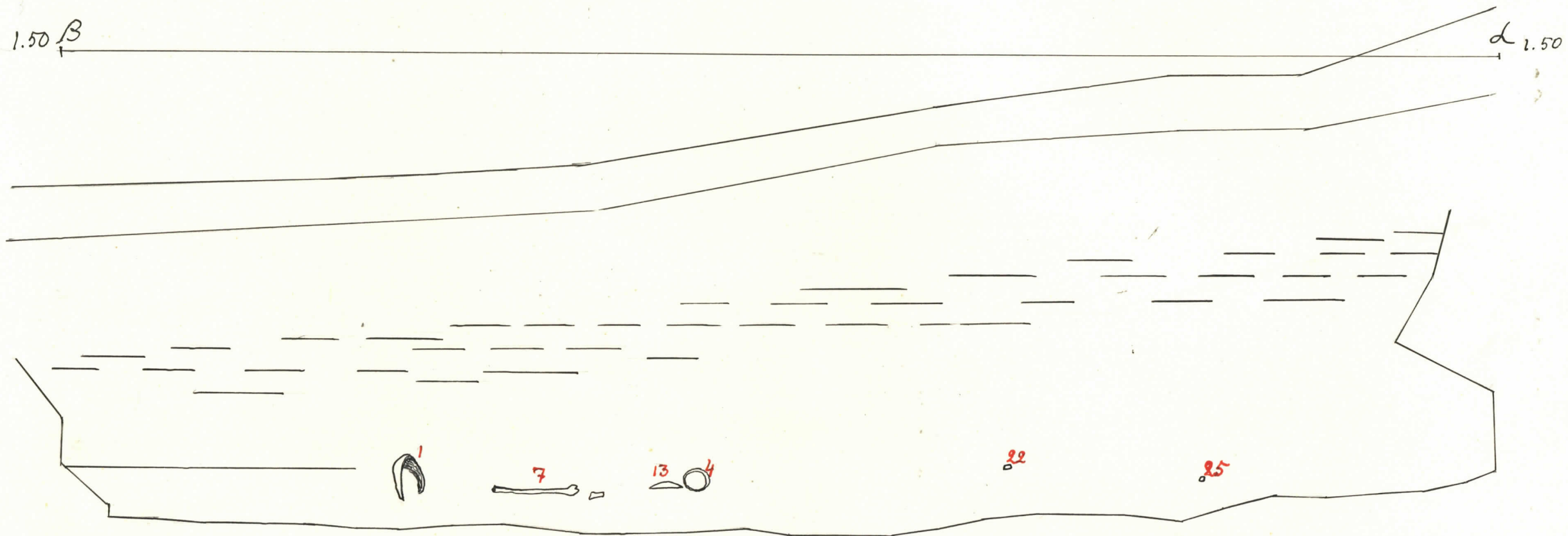

YLÄNE, ANIVEHMAANMÄKI
HAUTA LXIII:1
A-L HIRVILUOTO 1957
piirt. L-I Räsänen
1:10

B

- Haudan 1. ääriiviiva ————
 " 1. - " - " - - - -
 " 3. - " - " - - - -
- Nokimaan 1. ääriiviiva - - - -
 - " - 2. - " - " - - - -
 - " - 3. - " - " - - - -

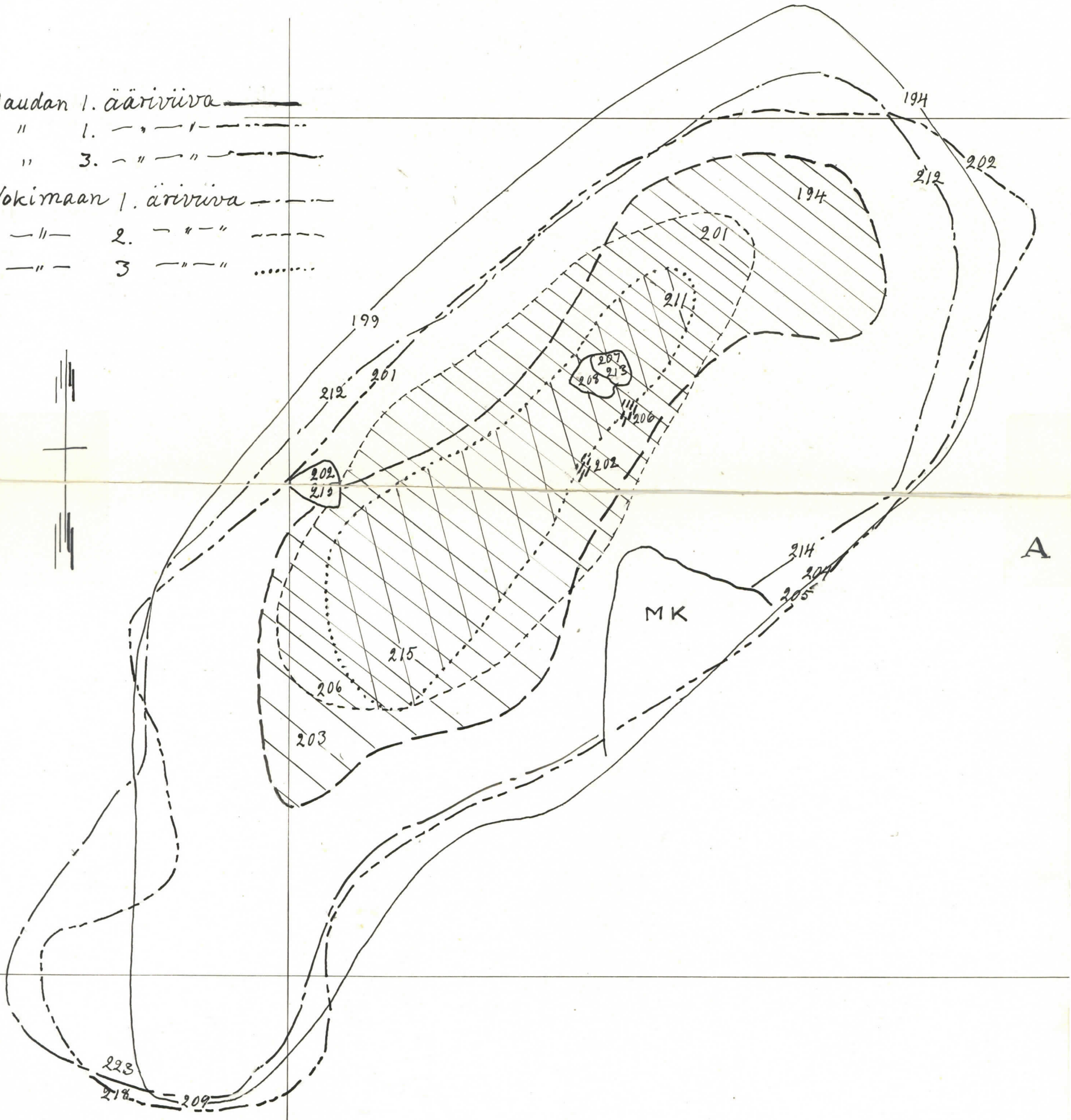

A

A,

YLÄNE, ANIVEHMAANMÄKI

HAUTA LXIII : 2

A-LHIRVILUOTO 1957

piirtä L-I Räsänen

1:10

B



18

17

230

222

234

222

226

231

207

224

212

218

214

225

218

222

232

220

A

235

226

253

232

A

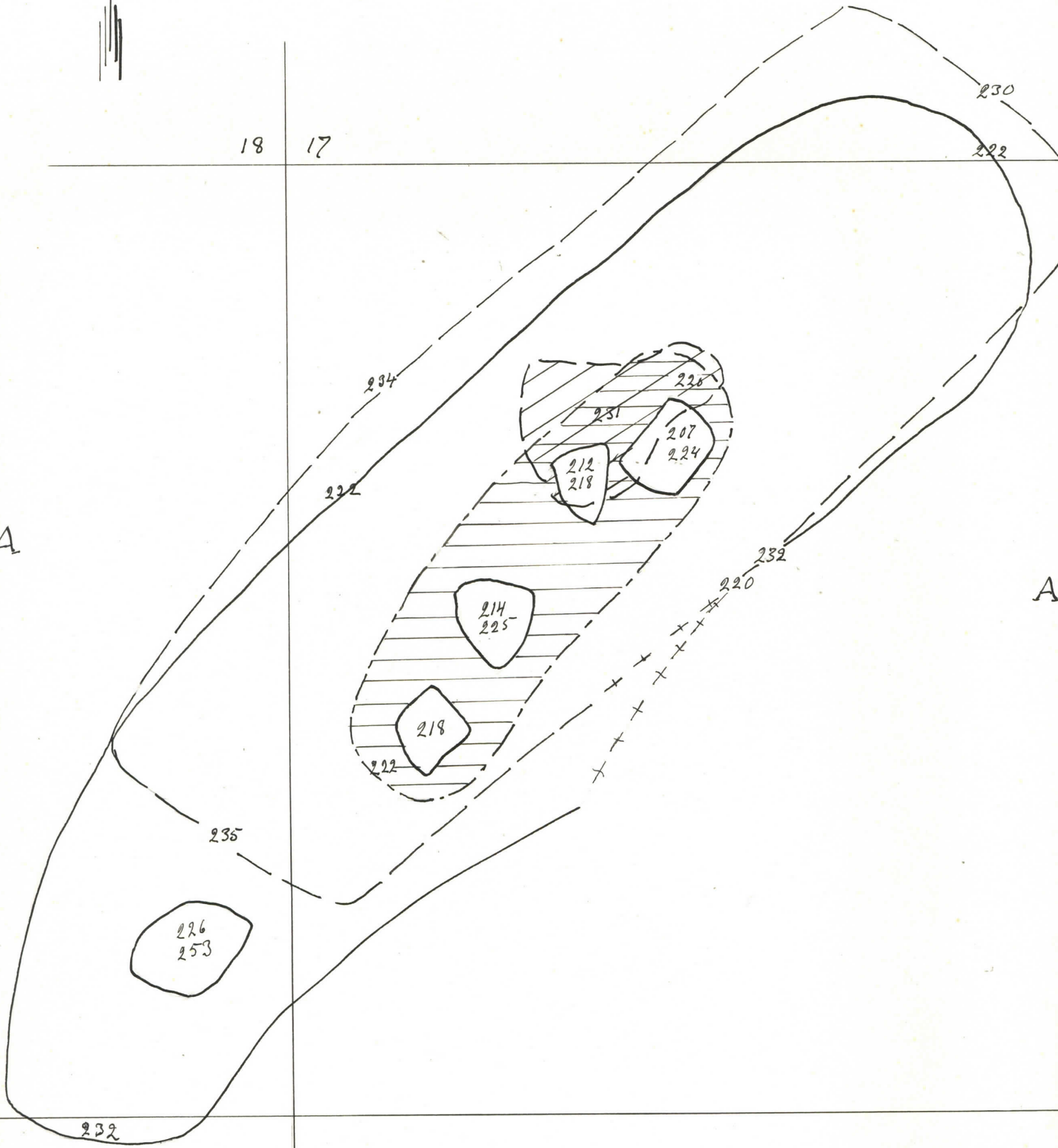

C

18

17

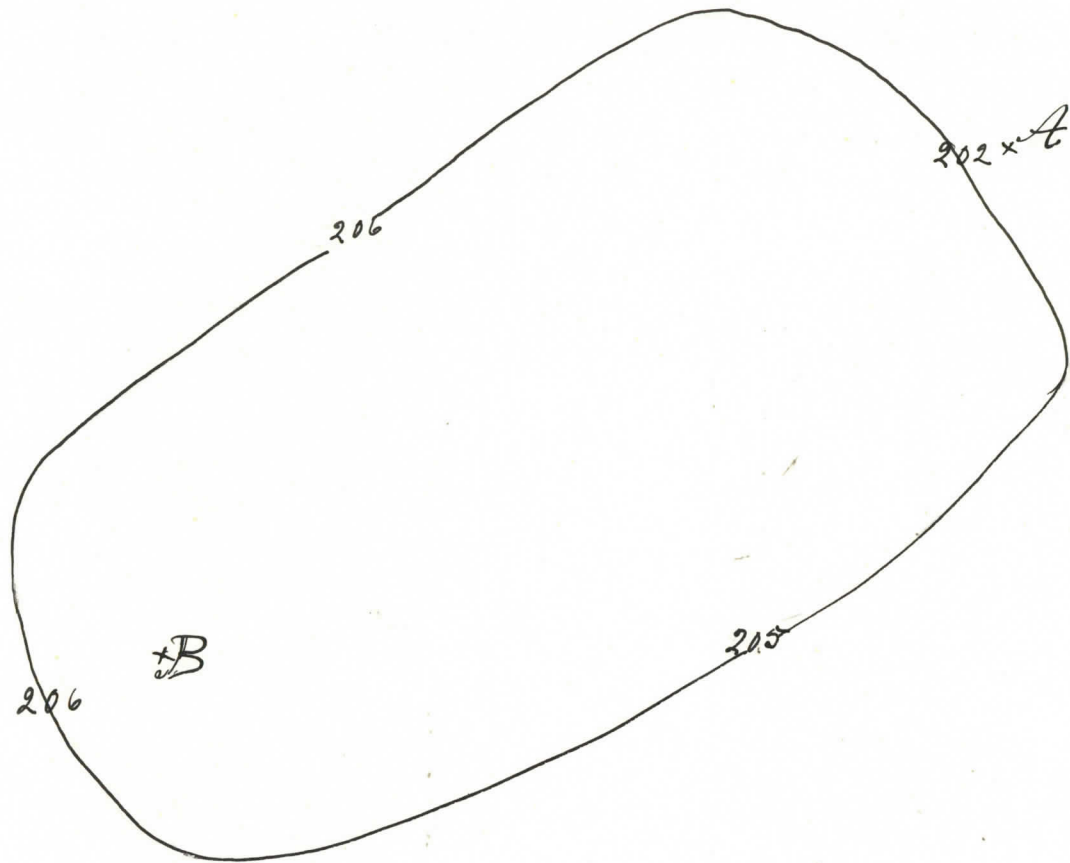
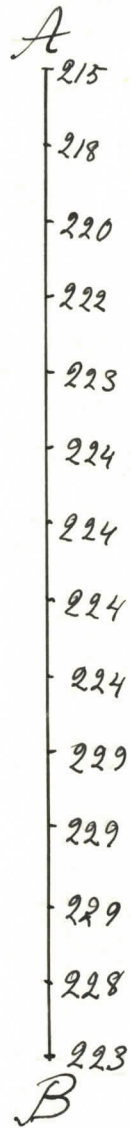

B

YLÄNE, ANIVEHMAANMÄKI
 HAUTA LXIII 62
 A-L HIRVILUOTO 1957
 piirt L-J Räsänen
 1:10

18

17

YLÄNE, ANIVEHMAANMÄKI
HAUTA LXTV:1 A, B
A-L HIRVILUOTO 1957
piirt. Paavo Huovari
1:10

20 19

19 18

A,
B,

A,
B,

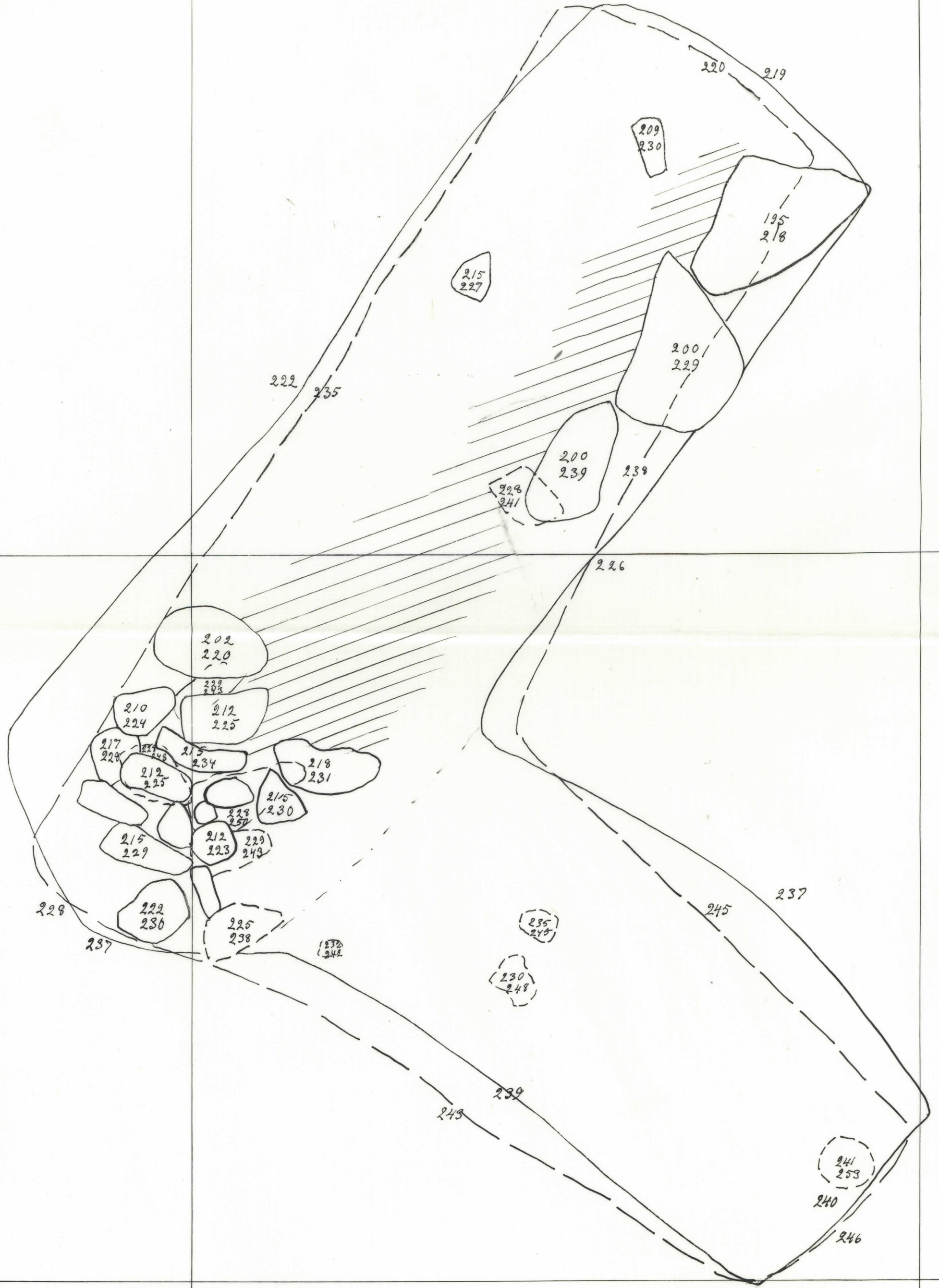

B,
C,

B,
C,

YLÄNE, ANIVEHMAANMÄKI
HAUTA LXIV: 2 A-B
A-L HIRVILUOTO 1957
piirt. Paavo Huovari
1:10

1 Keihäänkärki 258-261
2 puukko 262

14196 : 356
" : 357

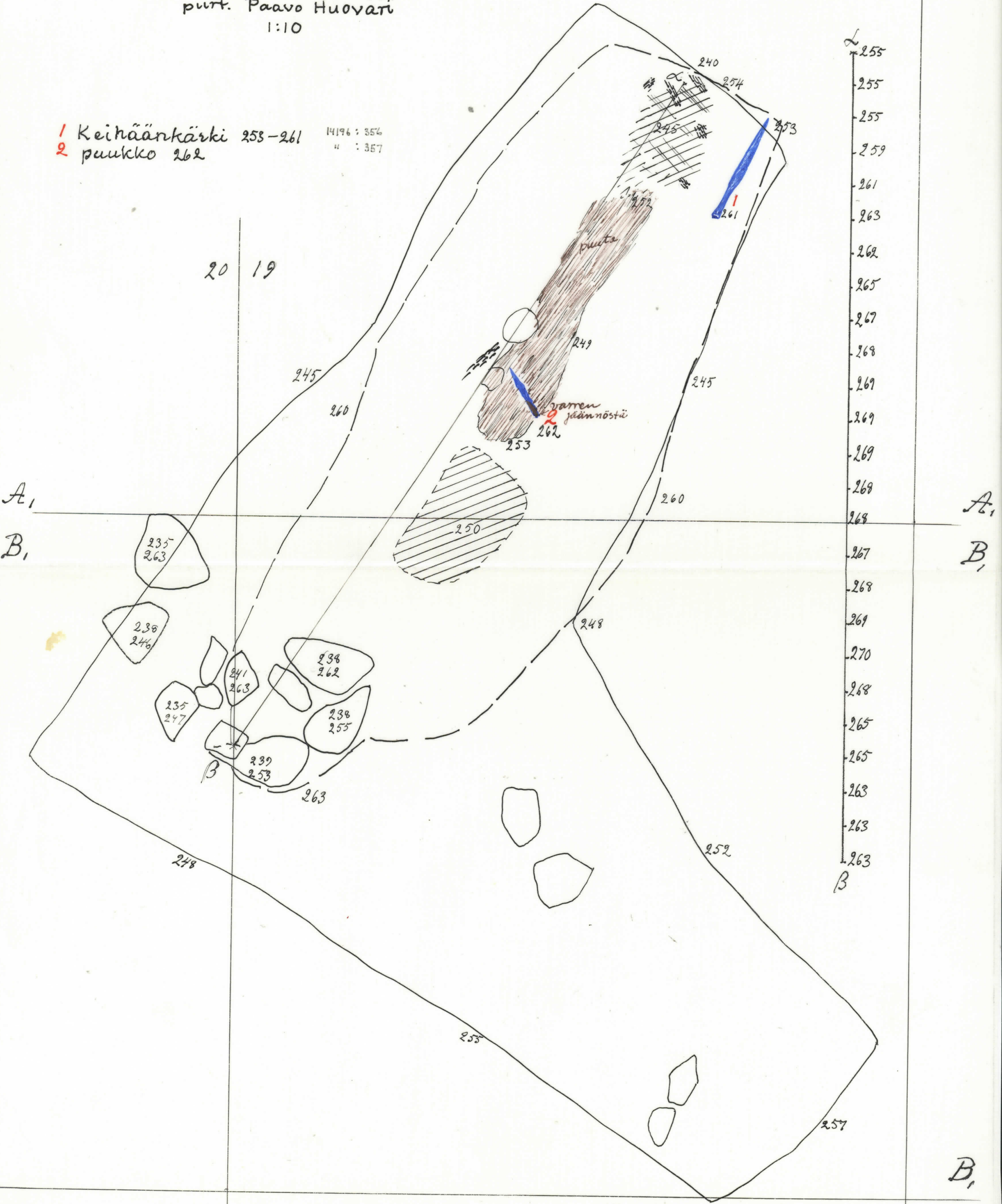

255
255
255
259
261
263
262
265
267
268
269
269
269
269
269
268
267
268
268
269
270
268
265
265
263
263
263
263
B

20 19

A₁
B₁

A₂
B₂

20 19

19 18 C

YLÄNE, ANIVEHMAANMÄKI
 HAUTA LXV:2
 A-L HIRVILUOTO 1957
 piirt. Paavo Huovari
 1:10

- | | | |
|---------------|-----|---|
| keihäänkärki | 233 | 1 |
| pronssirengas | 228 | 2 |
| " | 235 | 3 |
| " | 234 | 4 |
| pr. sokki | 239 | 5 |

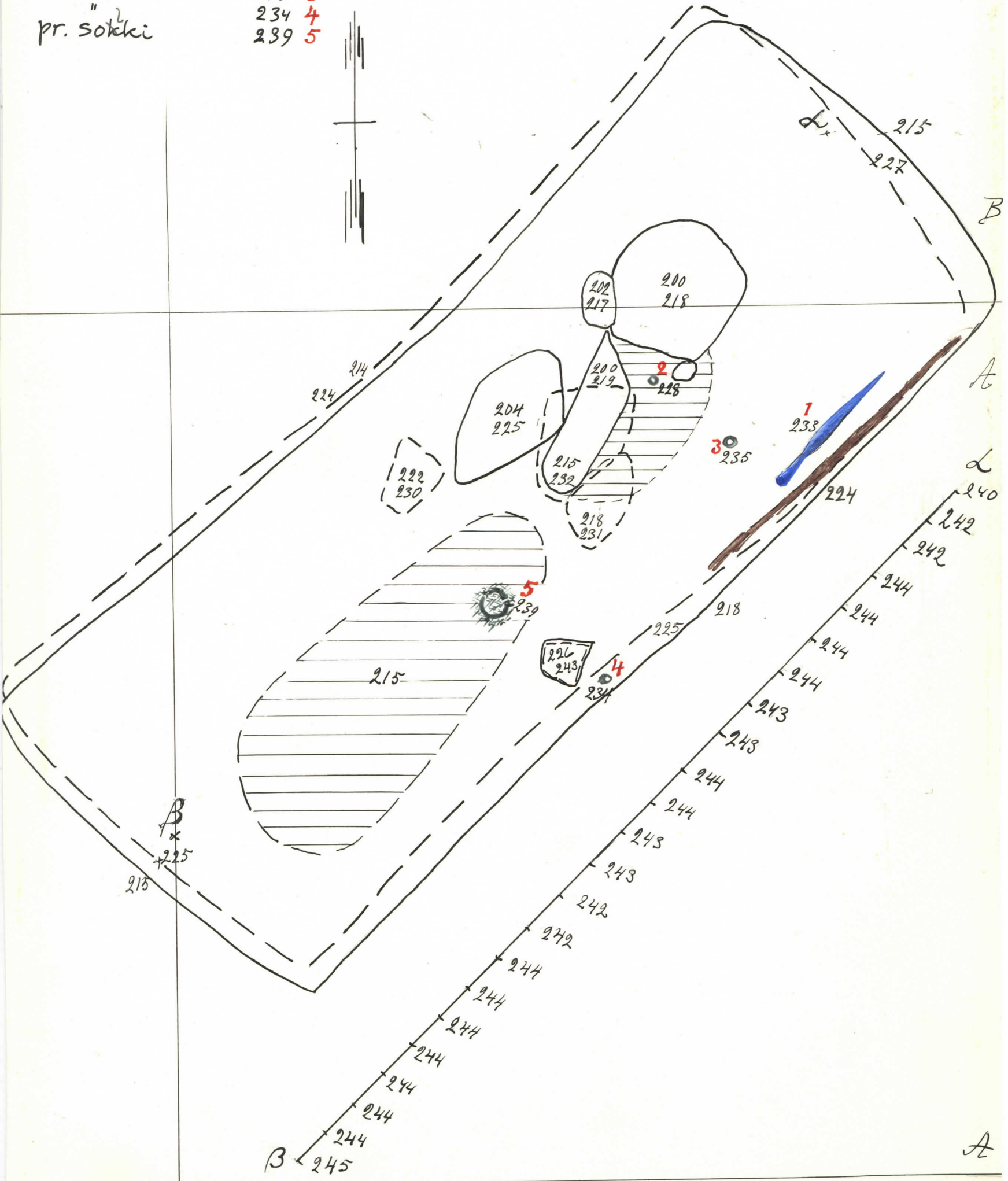

YLANE, ANIVEHMAANMÄKI
 HAUTA~~LXVI~~ : I
 A-L HIRVILUOTO 1957
 piirt. L-I Räsänen
 1:10

hiltä

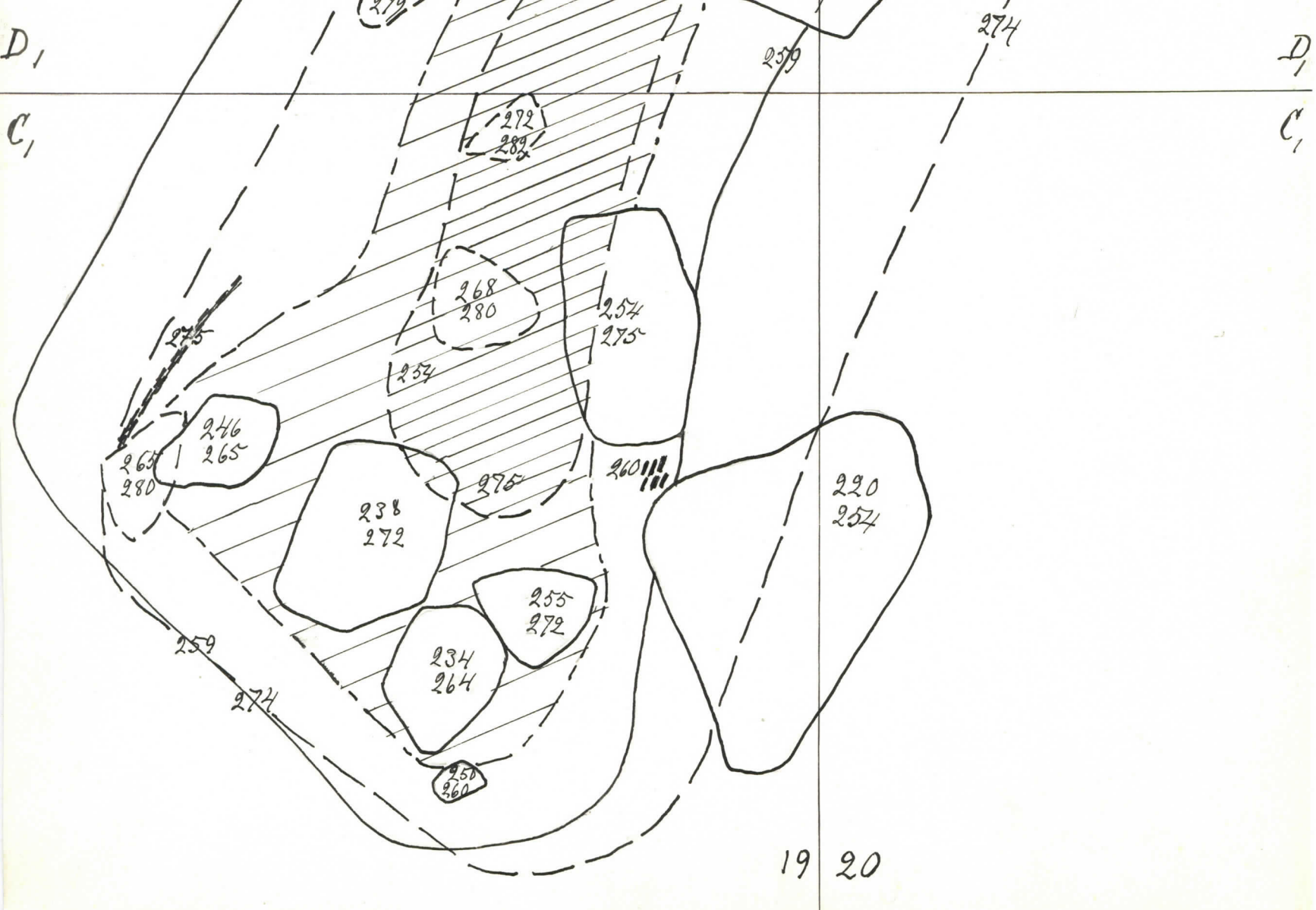

YLÄNE ANIVEHMAANMÄKI
HÄUTA LXVI : 2
A-L HIRVILUOTO 1957
piirt. L-1 Räsänen
1:10

//
// hiiltä
//

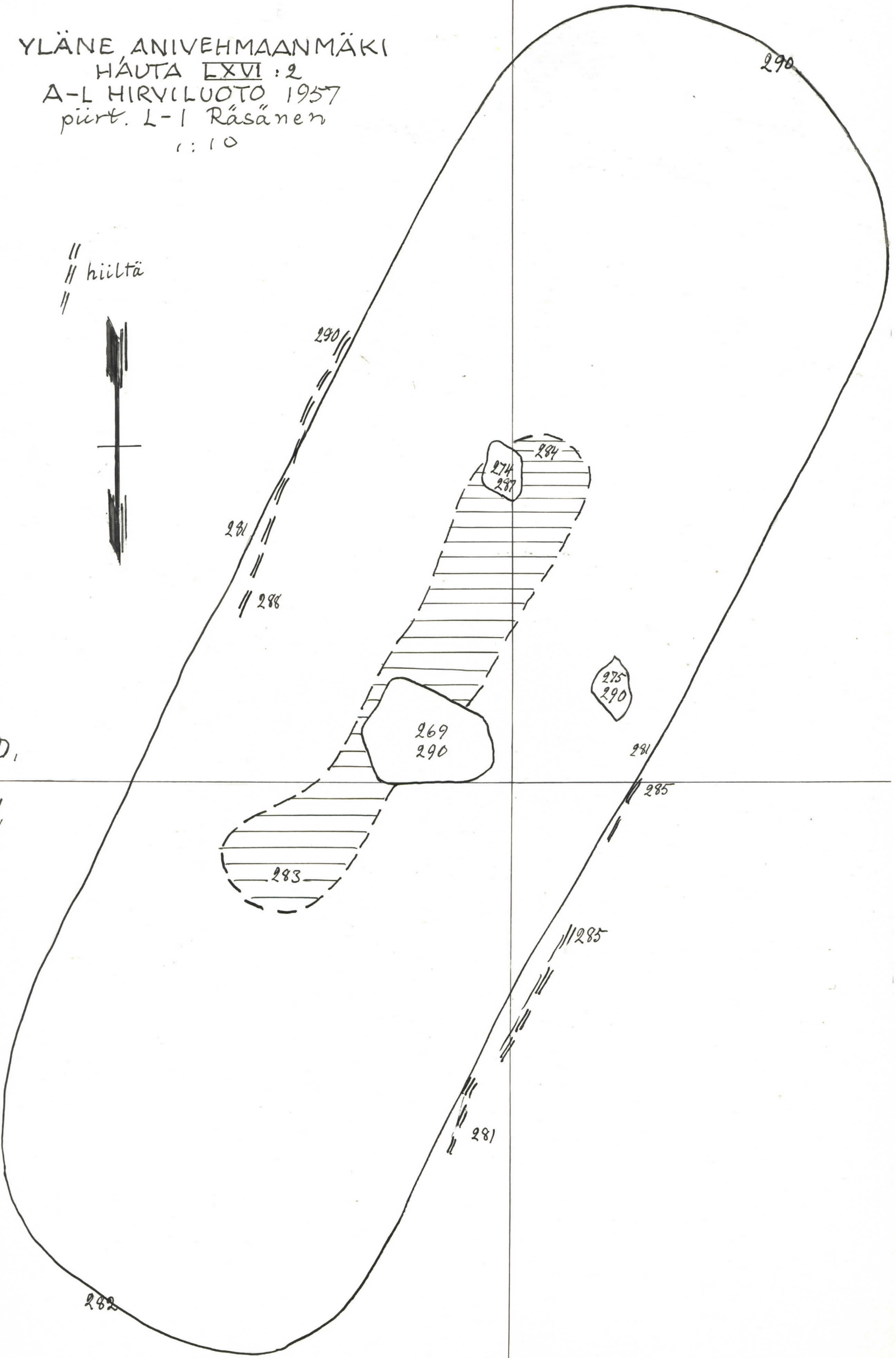

D₁

C₁

YLÄNE, ANIVEHMAANMÄKI
HAUTA LXVI:61
A-L HIRYILUOTO 1957
piirt. L-I Räsänen
1:10

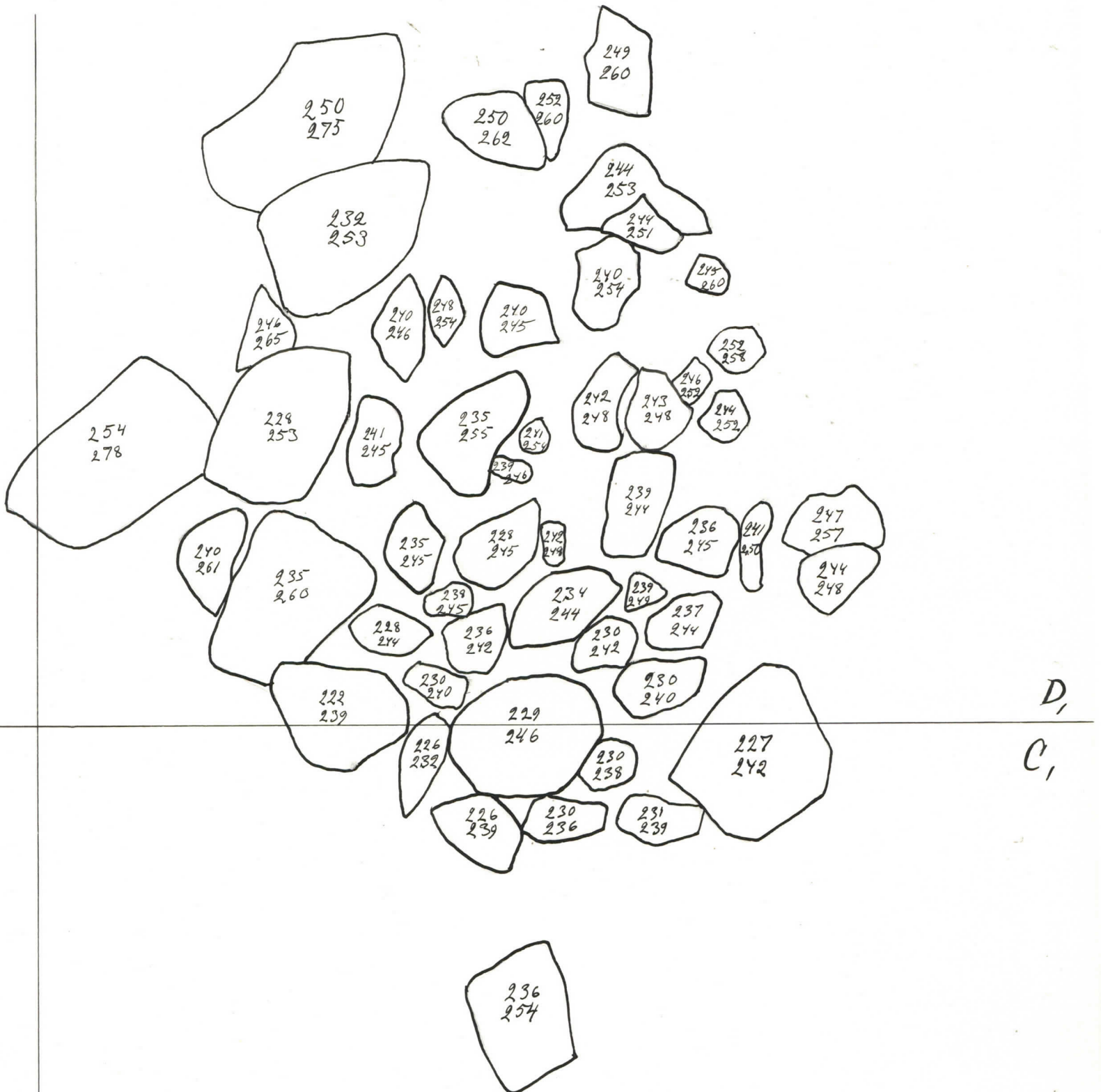

YLÄNE, ANIVEHMAANMÄKI
 HAUTA LXVII:1
 A-L HIRVILUOTO 1957
 piiri Paavo Huovari
 1:10



- | | | | |
|---|-----------------|-----|-----------|
| 1 | saviastian pala | 195 | 14196:376 |
| 2 | helmi | 193 | " : 377 |
| 3 | " | 192 | " : 378 |
| 4 | rautanaula | 194 | " : 379 |

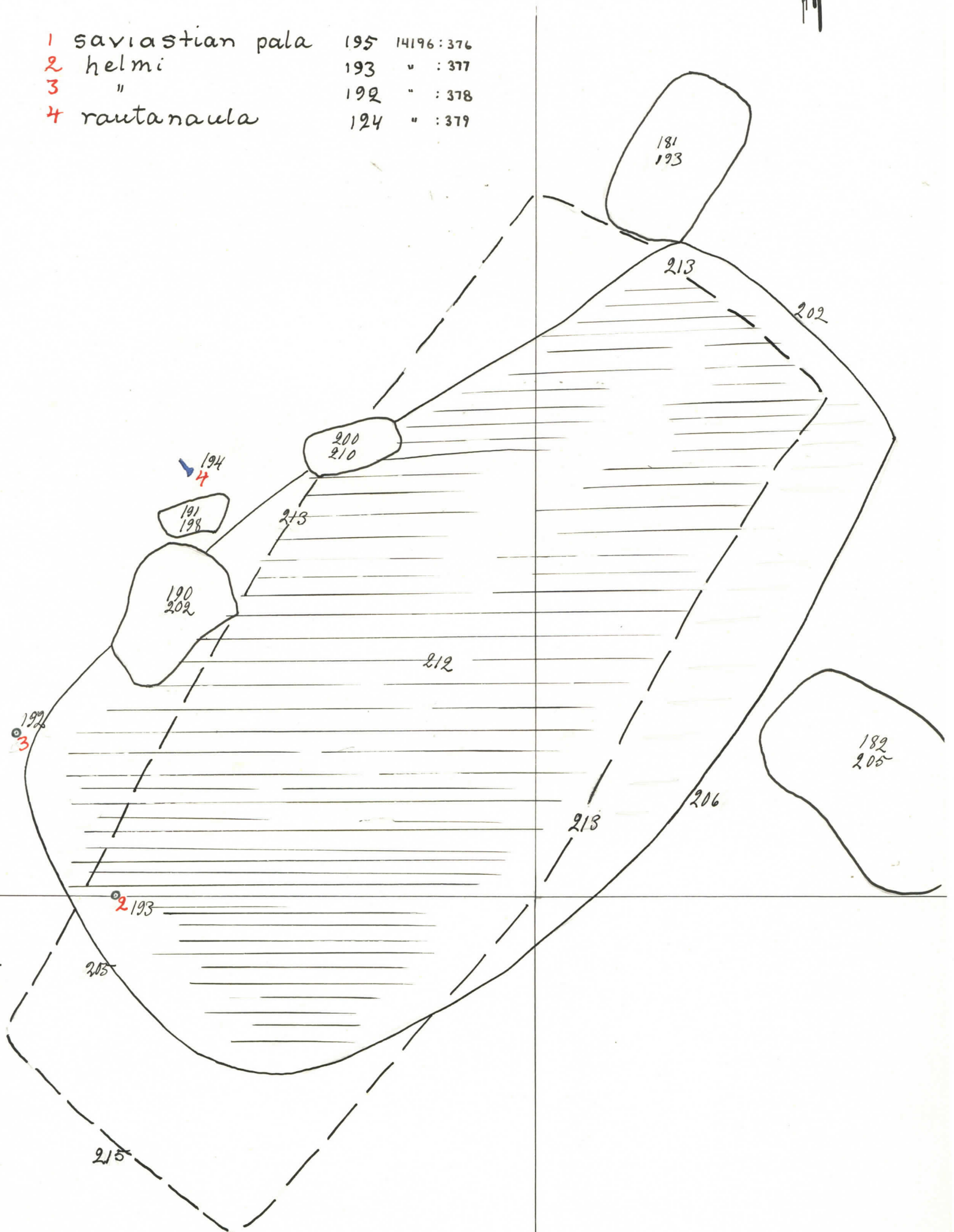

YLÄNE, ANIVEHMAANMÄKI
HAUTA LXVII:2
A-L Hirviluoto 1957
piirt. Paavo Huovari
1:10



B

A

5	helmi	227	14196:380
6	"	243	" : 381
7	"	247	" : 382
8	rautaa	249	" : 383

A

246
246
243
246
247
250
253
255
256
257
256
255
256
256
254
252
249
248
246

B

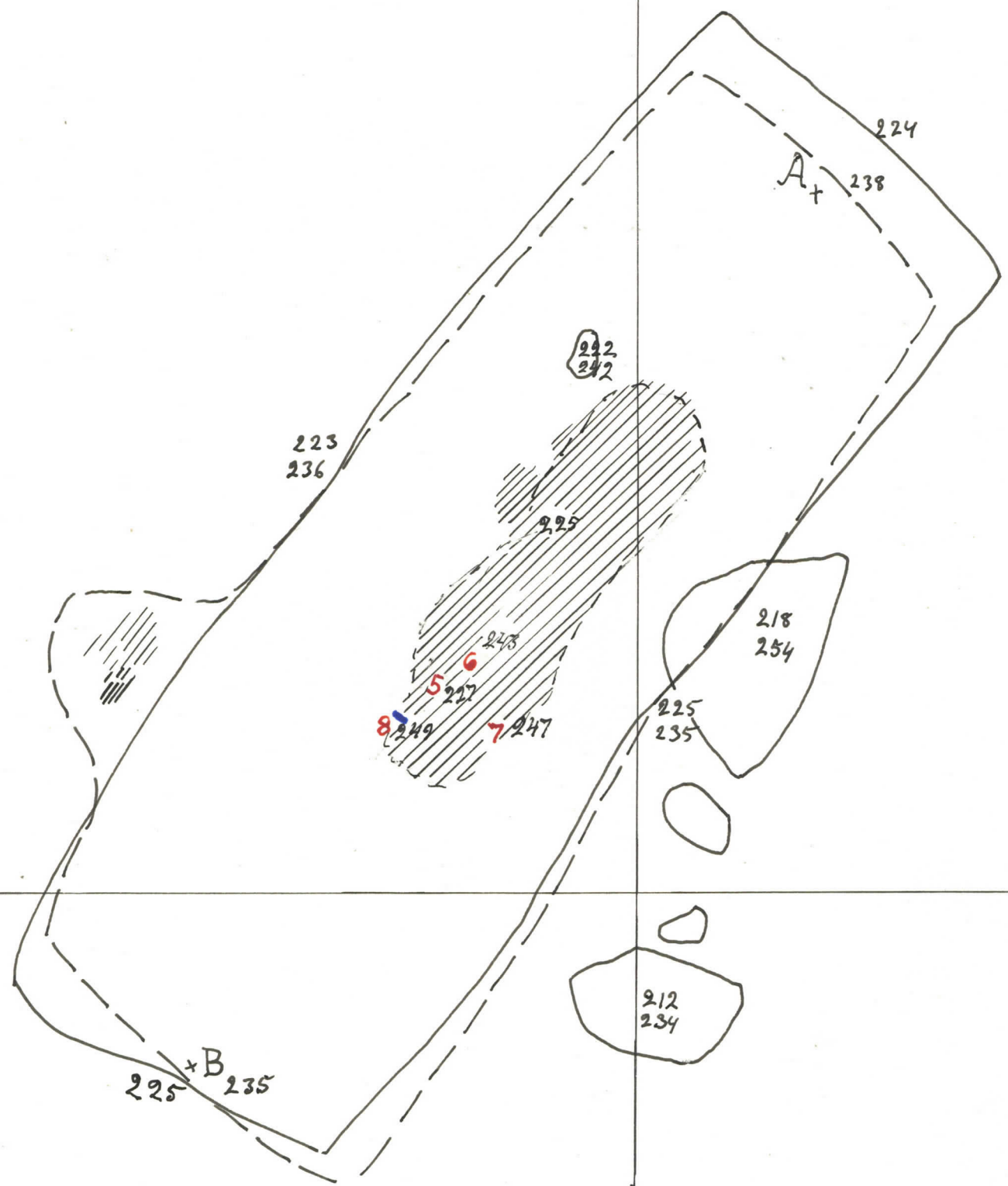

A

A₁

YLÄNE, ANIVEHMAANMÄKI
HAUTA LXXVII
Profili
A-L Hirviluoto 1957
piirt. L-J Räsänen
1:10

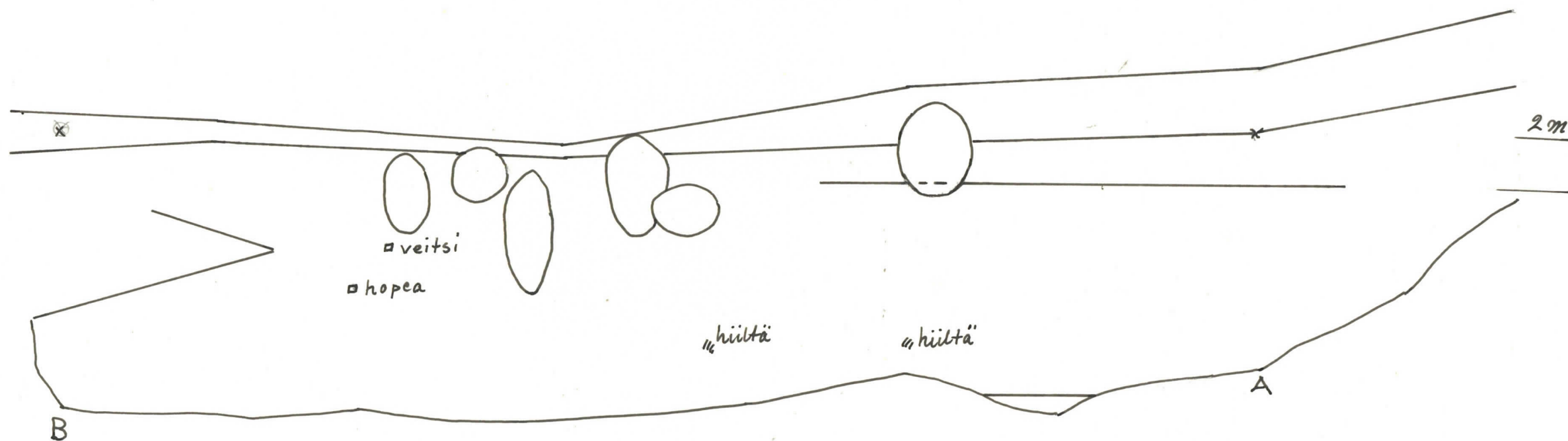

YLÄNE, ANIVEHMAANMÄKI
HAUTA EXVIII : I
A-LHIRVILUOTO 1957
piirt. Paavo Huovari
1:10

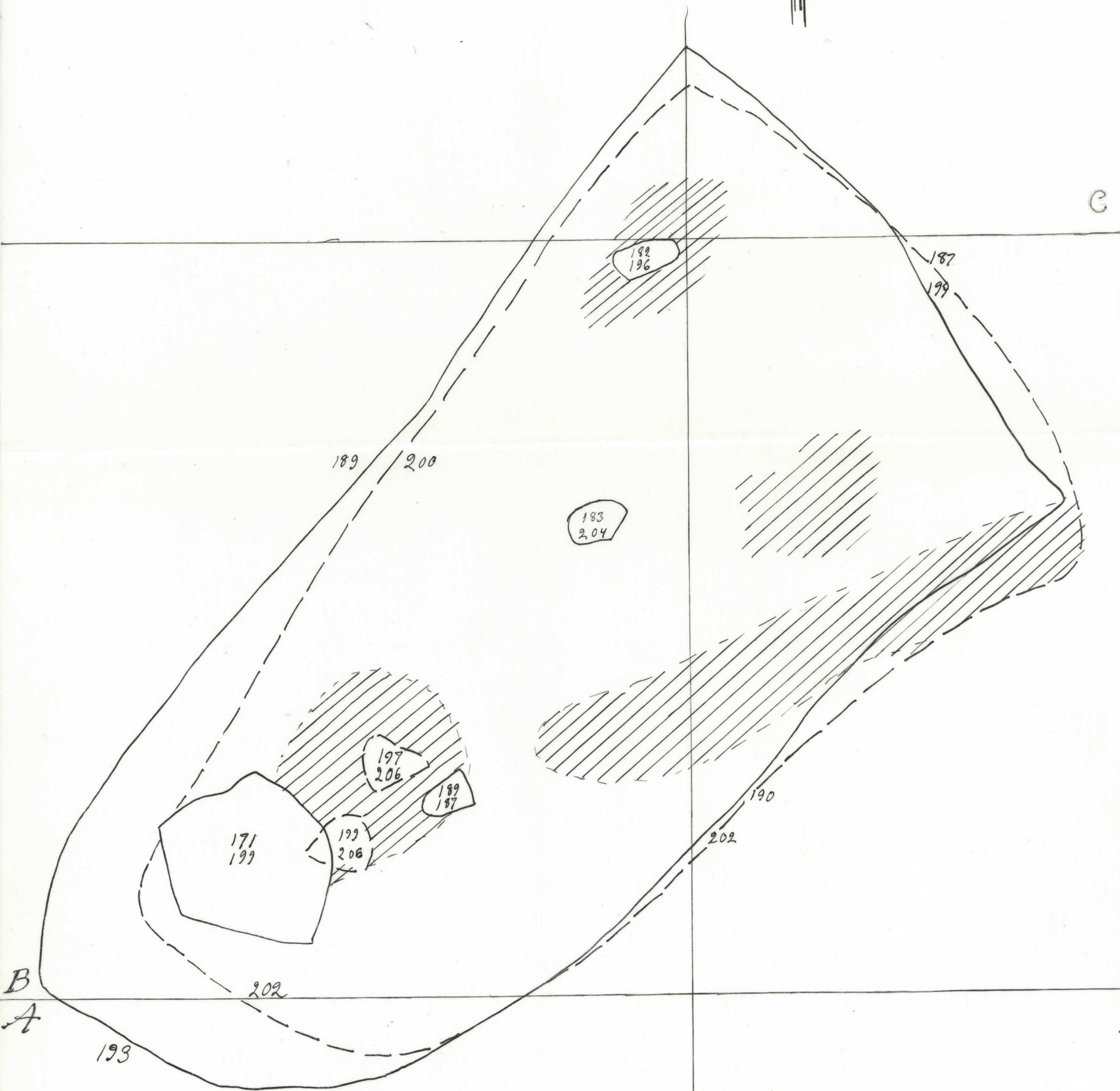

YLÄNE, ANIVEHMAANMÄKI
HAUTA LXVIII:2
A-L HIRVILUOTO 1957
piirt. Paavo Huovari
1:10

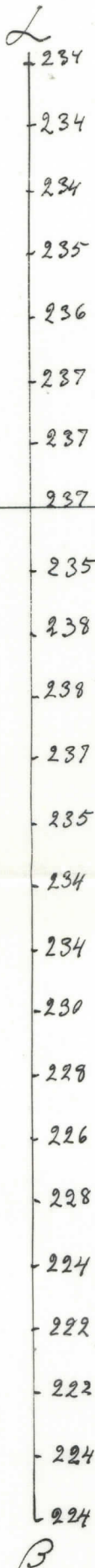

19 18

19 18

C

B

C

B

B

A

B

A

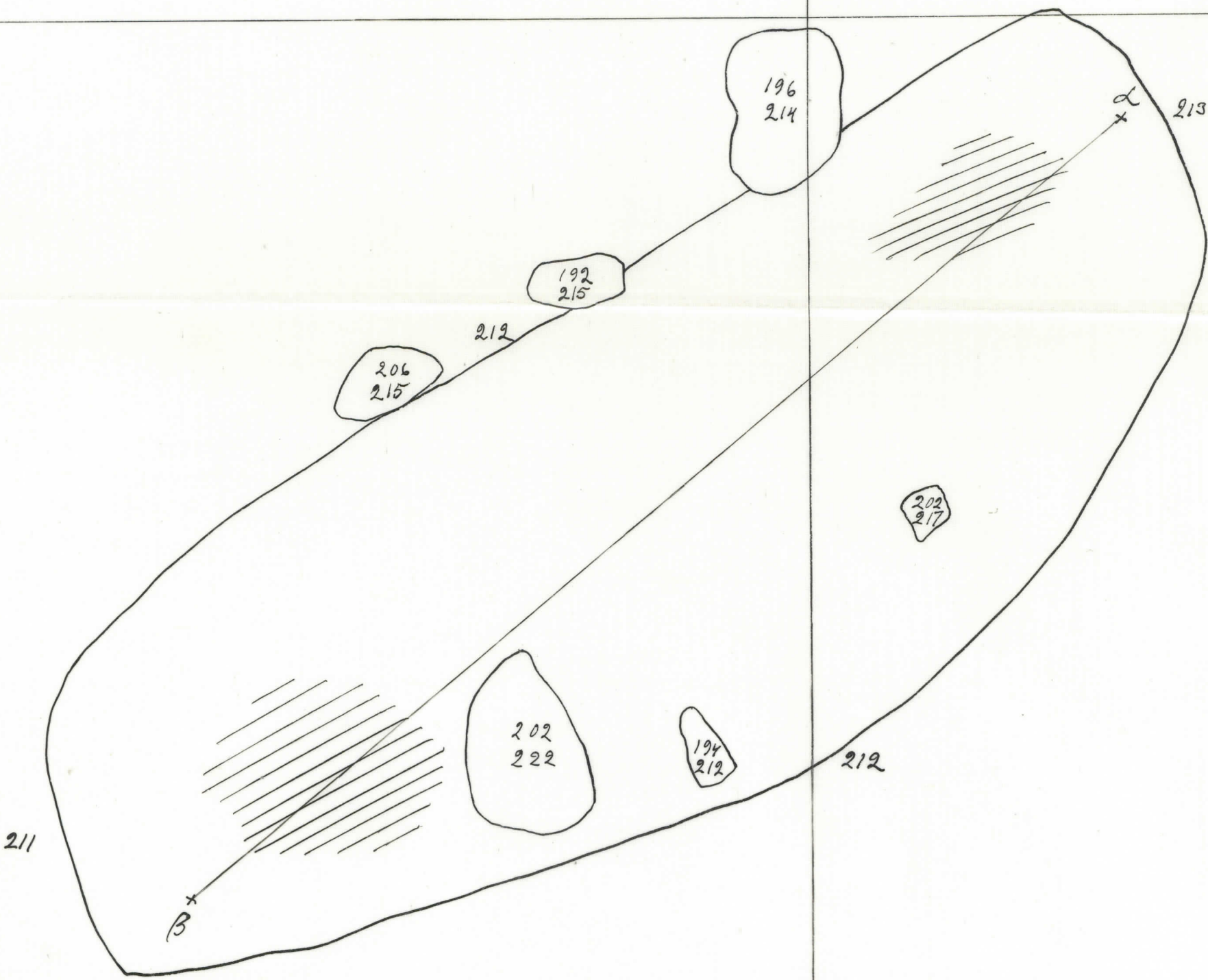

YLÄNE, ANIVEHMAANMÄKI
 HAUTA LXVIII:3
 A-L HIRVILUOTO 1957.
 piirtä Paavo Huovari
 1:10

5	helmi	227	14196:380
6	"	243	" : 381
7	"	247	" : 382
8	rautaa	249	" : 383

20 19

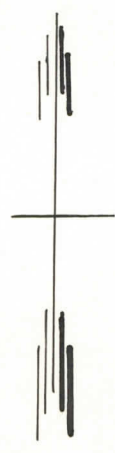

B

B

A

A

f

- 246
- 246
- 243
- 246
- 247
- 250
- 253
- 255
- 256
- 257
- 256
- 255
- 256
- 256
- 254
- 252
- 249
- 248
- 246

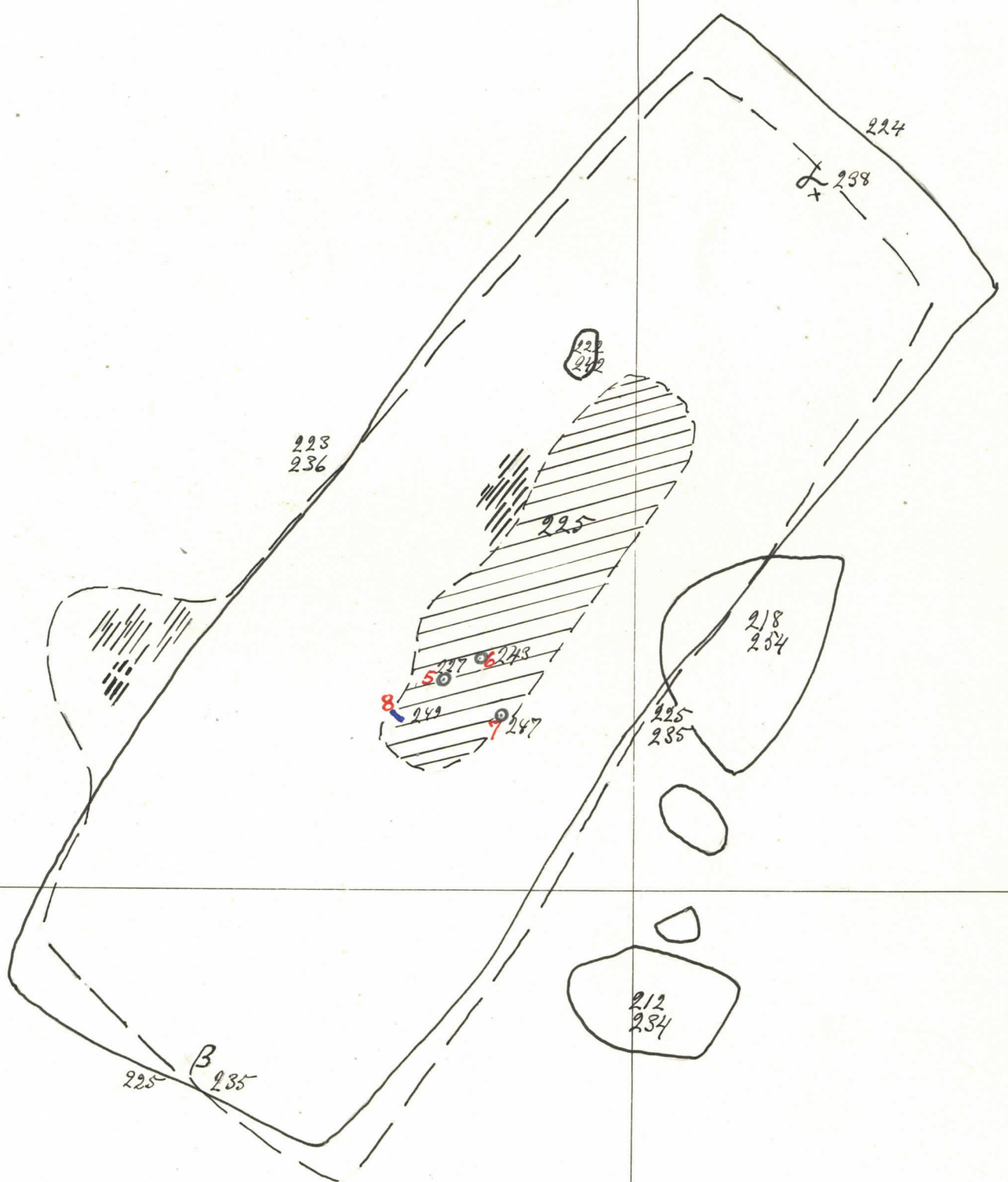

A

A,

20 19

YLÄNE, ANIVEHMAANMÄKI
HAUTA XIX: 1
A-L HIRVILUOTO 1957
piirt. Paavo Huovari
1:10

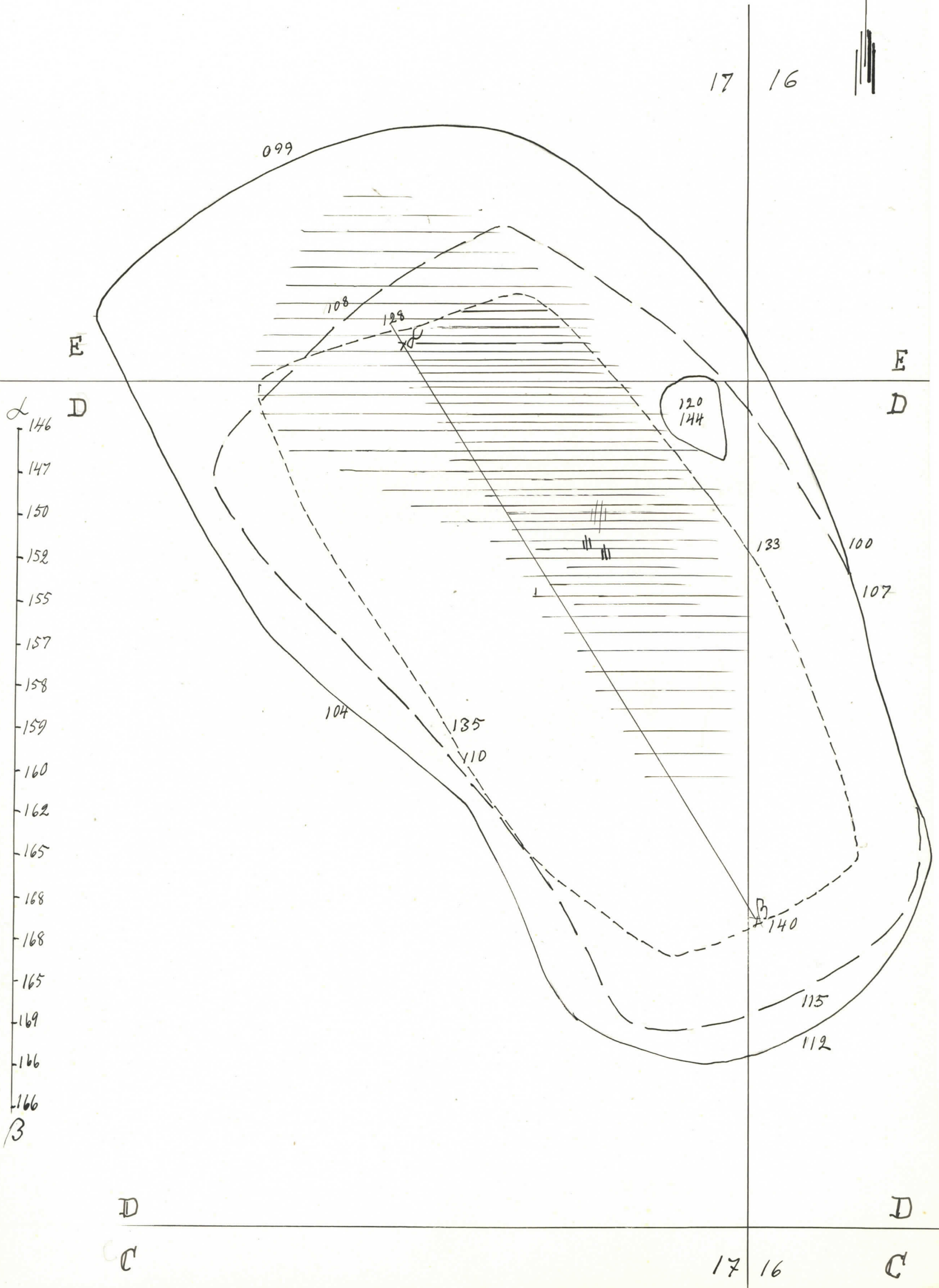

YLÄNE, ANIVEHMAANMÄKI
 HAUTA LXX:1
 A-L HIRVILUOTO 1957
 piirt; L-I Räsänen
 1:10

14196: 385	1 hevosenkenkäsolki	366
" : 386	2 keihäänkärki	371-375
" : 387	3 rautaveitsi (?)	365
" : 388	4 rautaa	368
" : 389	5 rautaa (nauha)	361
" : 390	6 rautaa	361
" : 391	7 rautaa (avain?)	368

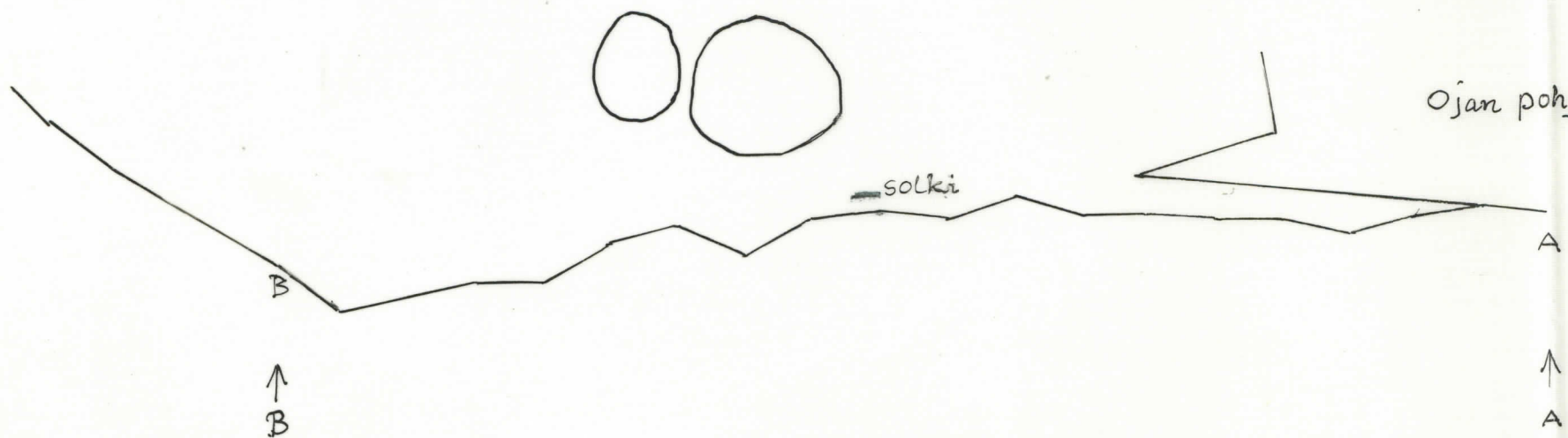
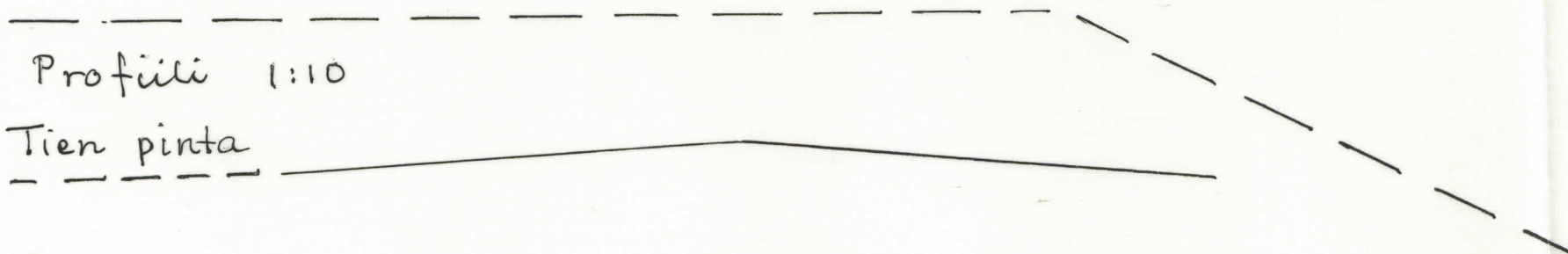
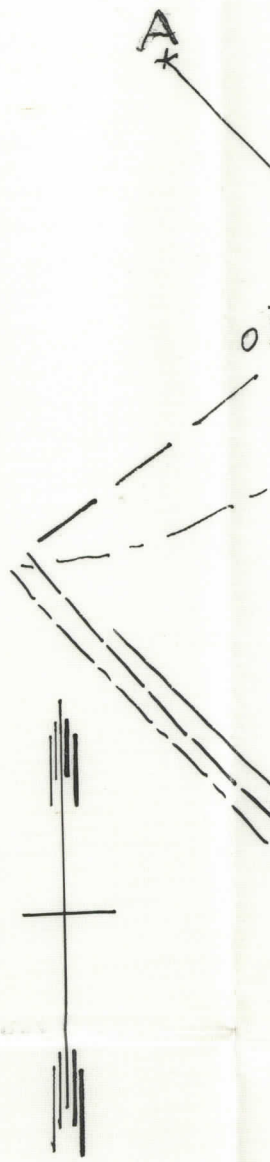

YLÄNE, ANIVEHMAANMÄKI
HAUTA LXXI:1

A-L HIRVILUOTO 1957
piirt. Paavo Huovari
1:10

1	helmi	190	14196:392
2	"	195	" : 393
3	"	195	" : 394
4	" (2 kpl)	197	" : 395
5	"	194	" : 396
6	sormus	198	" : 397
7	helmi	199	" : 398
8	"	201	" : 399
9	"	200	" : 400
10	"	202	" : 401
11	"	200	" : 402
12	"	202	" : 403
13	hiomkivi	212	" : 404
14	helmi	211	" : 405
15	pronssirengas	216	" : 406

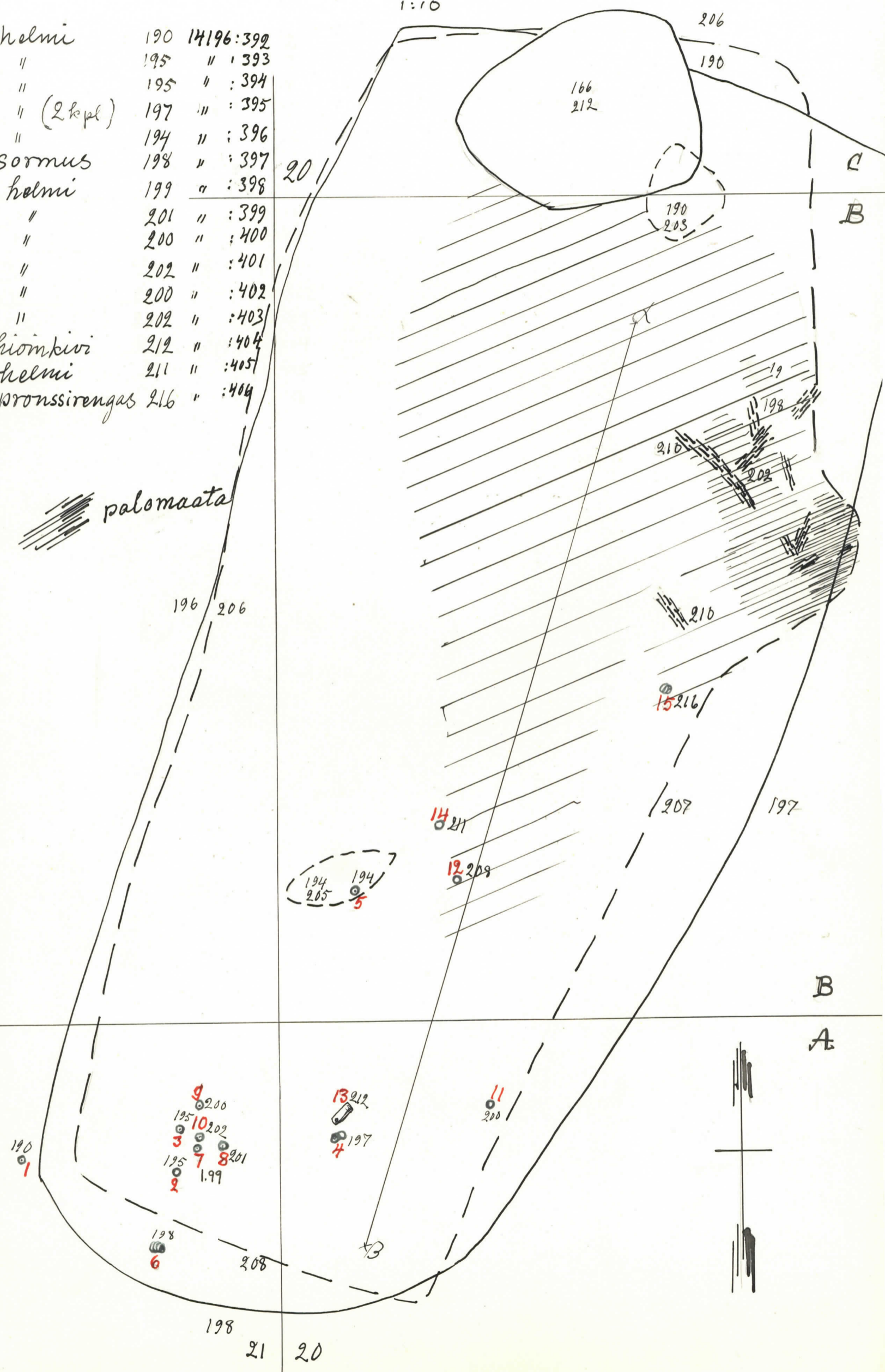

- 16 helmi 225 14196:407
- 17 " 220 " :408
- 18 " 214 " :409
- 19 " 218 " :410
- 20 keihäänkärki 222 " :411
- 21 sormus (sis.luuta) 225:412
- 22 " 230 " :413
- 23 helmi 229 " :414
- 24 " 226 " :415
- 25 " 227 " :416
- 26 " 227 " :417
- 27 " 227 " :418
- 28 helminauha 230 " :419
- 29 helmi 223 " :420
- 30 " 223 " :421
- 31 " 224 " :422
- 32 " 227 " :423
- 33 " 234 " :424
- 34 pronssia 238 " :425
- 35 sormus 215 " :426

YLÄNE, ANIVEHMAANMÄKI
 HAUTA LXXI. 2
 A-L HIRVILUOTO 1957
 piirt. Paavo Huovari
 1:10

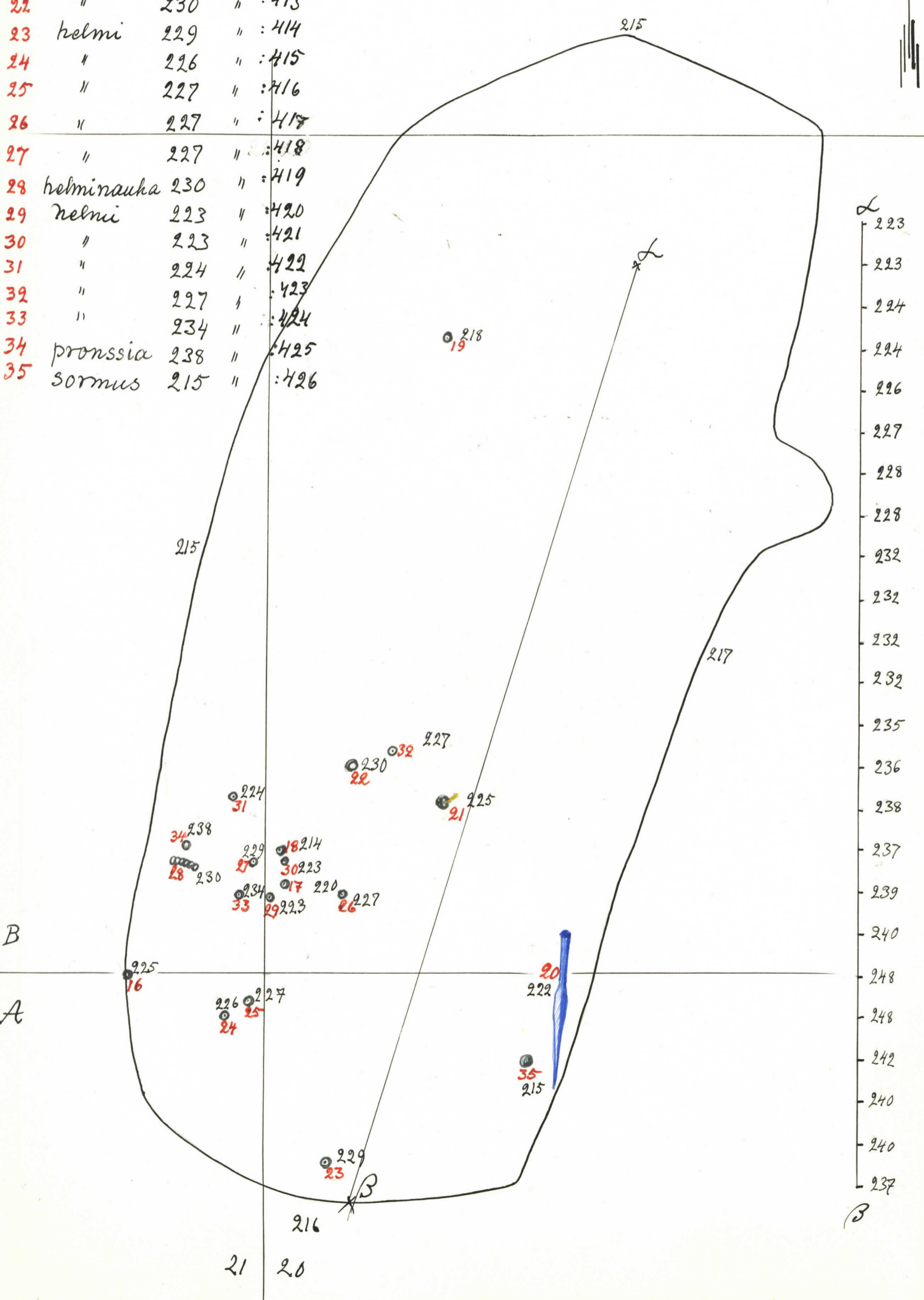

YLÄNE ANIVEHMAANMÄKI
 HAUTA IXXII:1
 A-LHIRVILUOTO 1957
 piirt. L-I Räsänen
 1:10

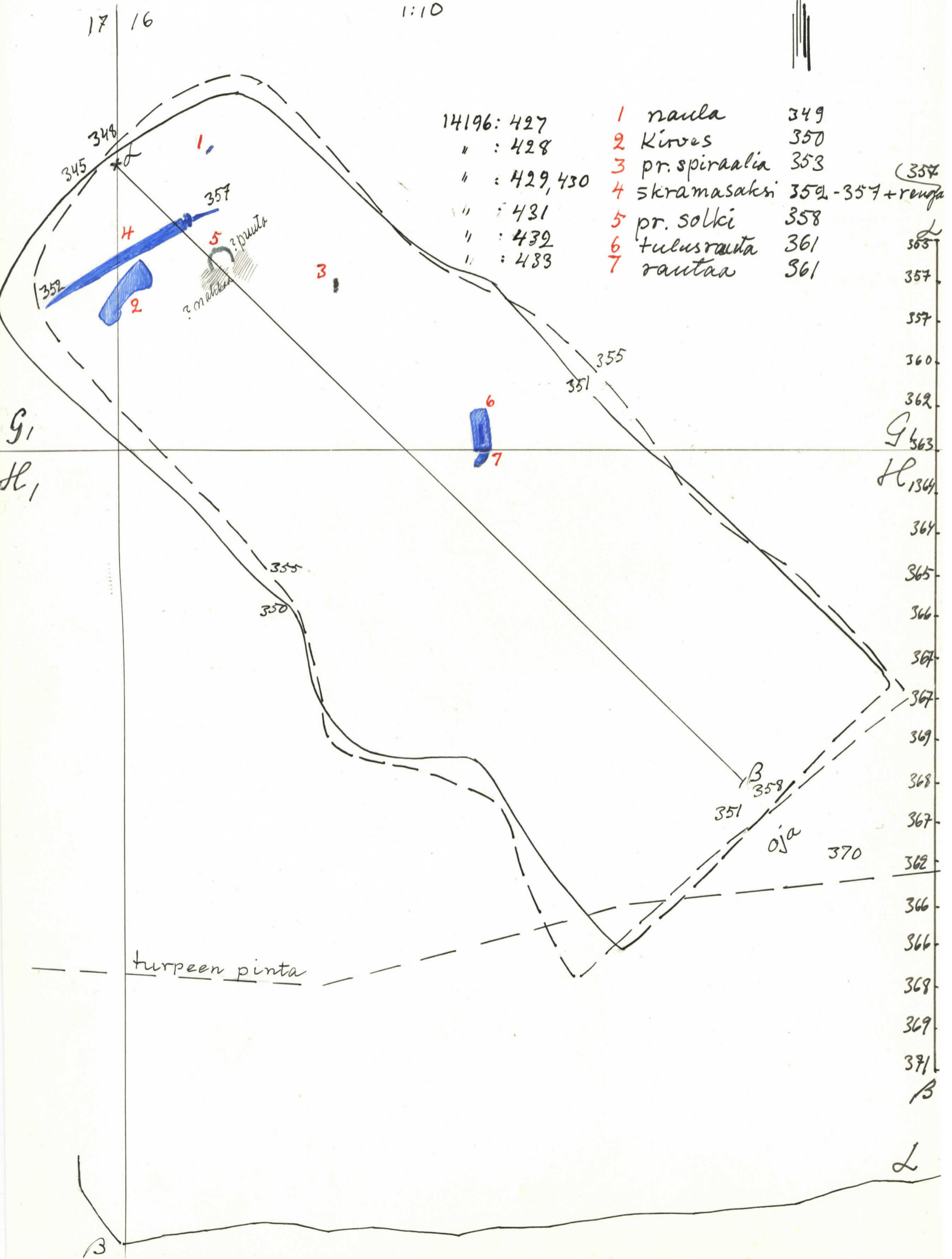

14196: 427
 " : 428
 " : 429, 430
 " : 431
 " : 432
 " : 433

- | | | | |
|---|---------------|------------------|-------|
| 1 | naula | 349 | |
| 2 | Kirves | 350 | |
| 3 | pr. spiraalia | 353 | (357) |
| 4 | skramasaksi | 352-357 + rengas | |
| 5 | pr. solki | 358 | |
| 6 | tulusrauta | 361 | 363 |
| 7 | rautaa | 361 | 357 |

365
 357
 360
 362
 G1 363
 H1 364
 364
 365
 366
 367
 367
 369
 368
 367
 362
 366
 366
 368
 369
 371
 B
 L

YLÄNE, ANIVEHMAANMÄKI
 HAUTA EXXIII:1
 Pintalöytöjä
 A-L HIRVILUOTO 1957
 piirt. L-I Räsänen
 1:10

21 20

A

1	Kaksoishelmi	204	4196:434
2	keramiikkaa	204 - 224	" :435
3	"	215	" :436
4	"	215	" :437
5	pr. kierukkaa	212	" :438
6	keramiikkaa	199	" :439

A₁



H

!

A₁

21 20

B₁

3

2

YLÄNE, ANIVEHMA
 HAUTA LXXIII:2
 A-L HIRVILUOTO 193
 pürt. L-1 Räsäne
 1:10

7	keramikkaa	220	14196:	440
8	kolmoiskelmi	222	" :	441
9	pronssispirali	204	" :	442



A,

B,

204
213

202
220

208
229

212
219

212
225

8

22

21

21 20

AANMÄKI
2
1957
nen

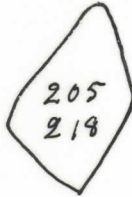
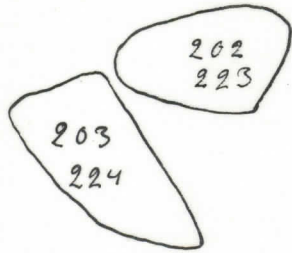

7

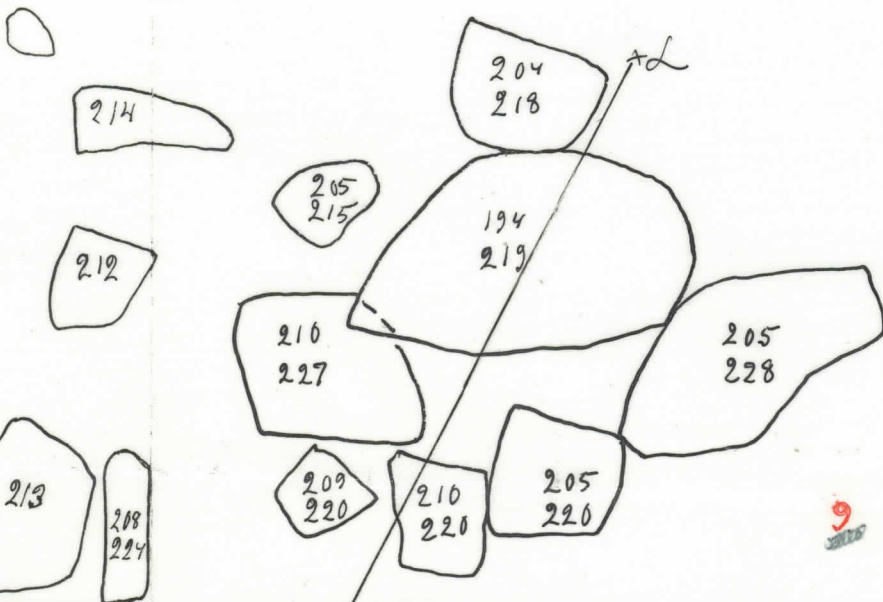
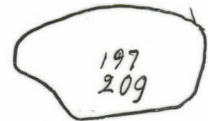
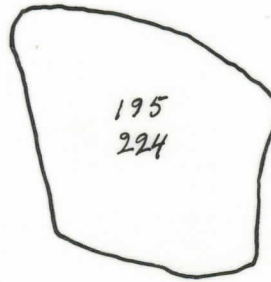

9

A,

B,

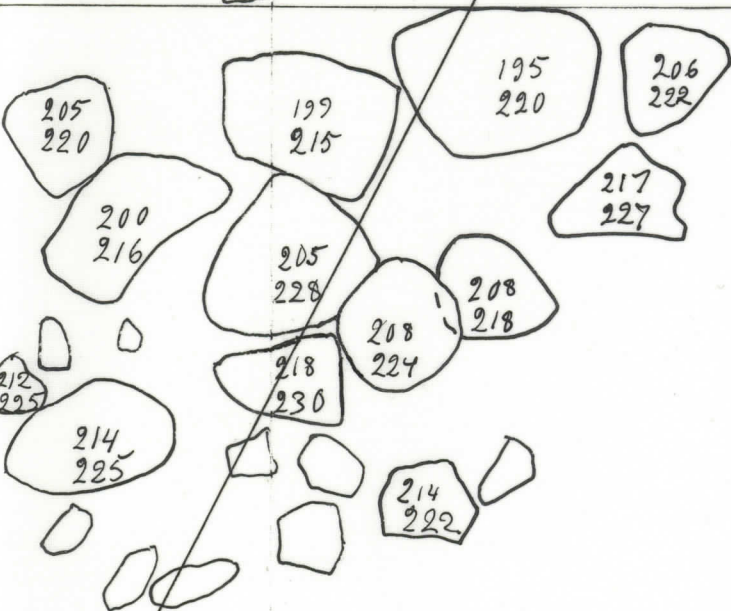

21 20

* B

YLANE, ANIVEHMAANMÄKI
HAUTA LXXIII:3 6
A-L HIRVILUOTO 1957
piirt. L-J Räsänen
1:10

21

20

A

A,

2 kivikerros

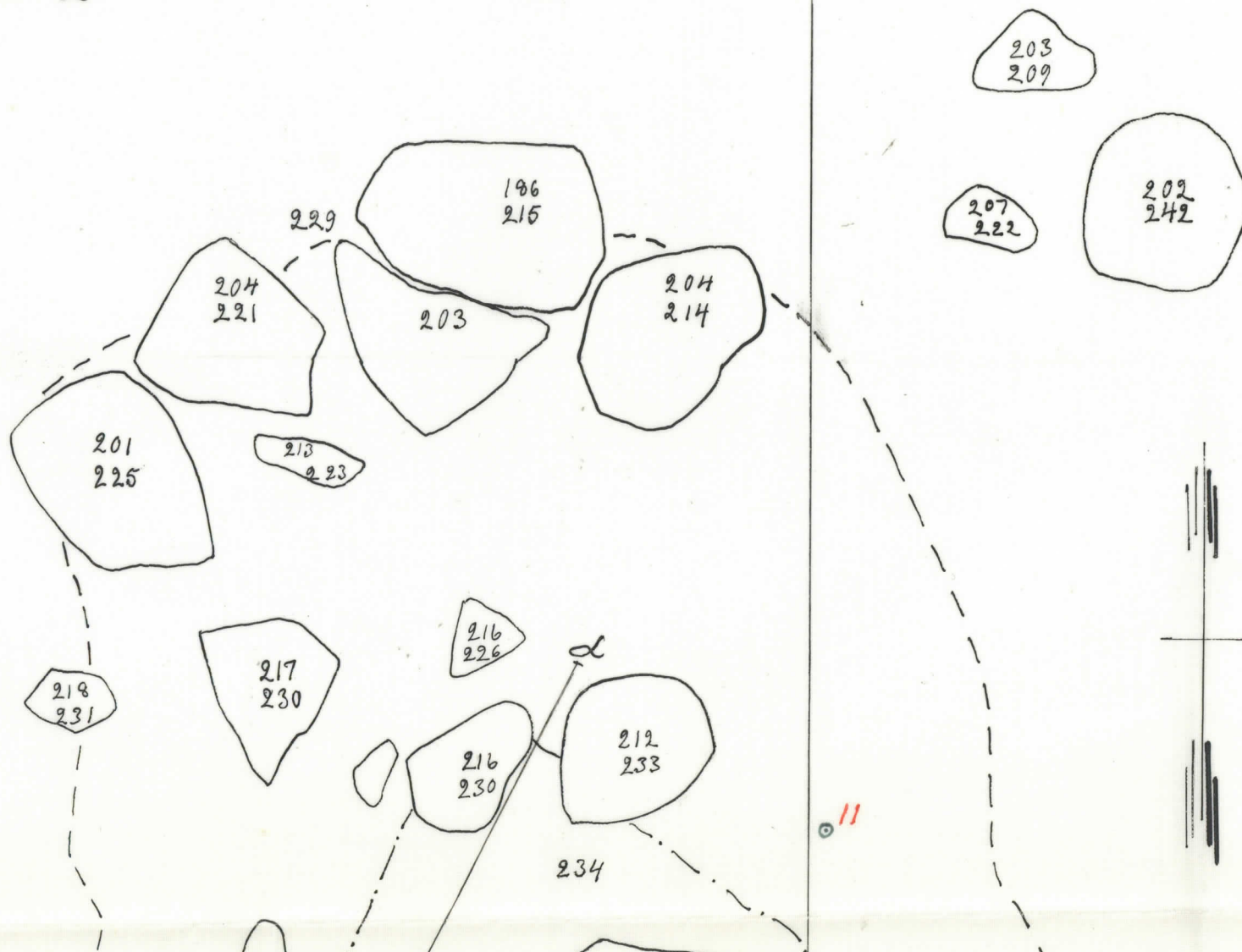

A,

A,

B,

B,

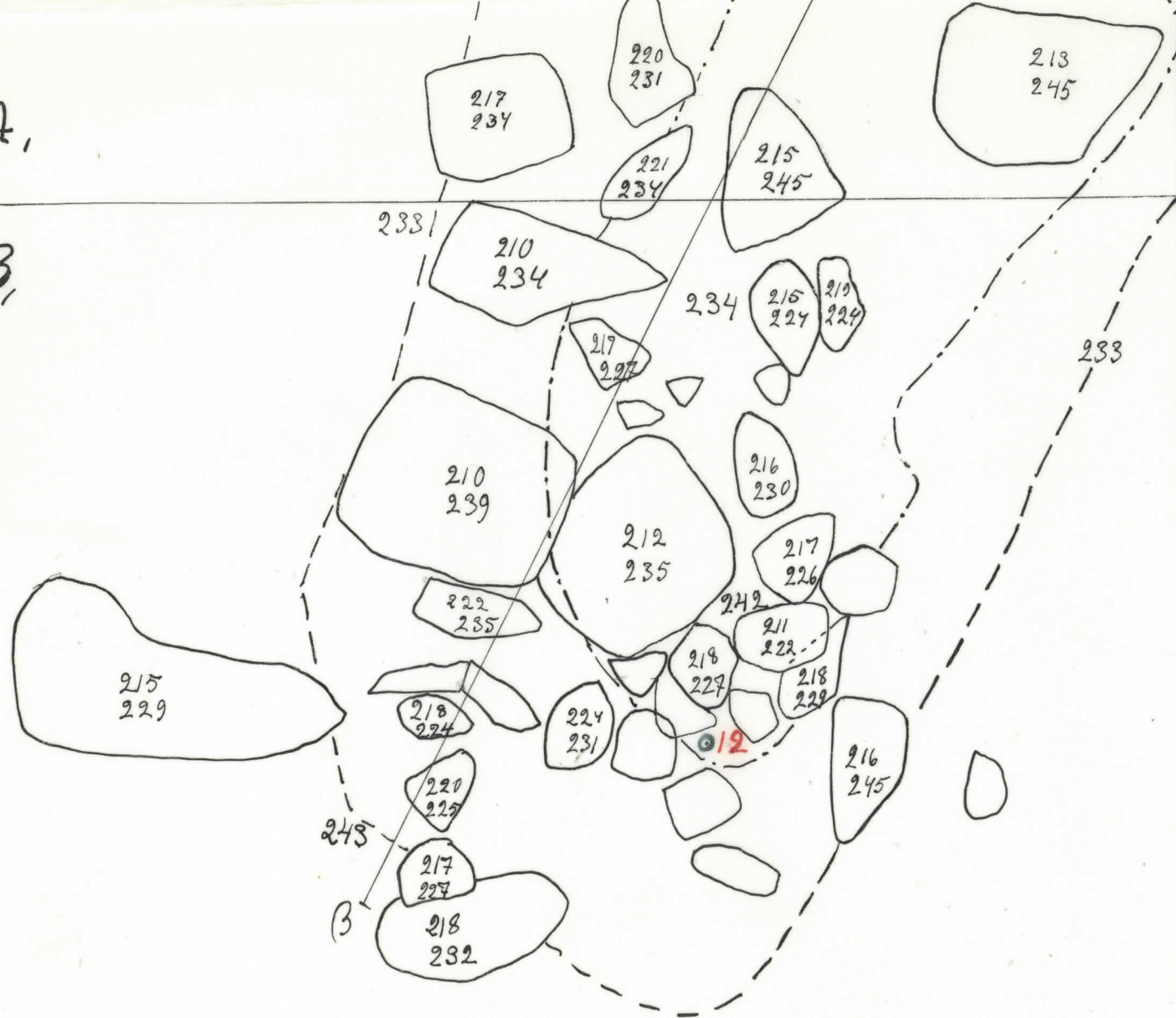

- 10 pronssisormus 224 14196 : 443
- 11 helmi 231 : 444
- 12 helmi 240 : 445

10

21

20

YLÄNE, ANIVEHMAANMÄKI

HAUTA LXXIII:4

A-LHIRVILUOTO 1957

piirt. L-I Räsänen

13	helmi	235	14196: 446 1:10
14	keramiikkaa	244-253	" : 447
15	kaksoishelmi	245	" : 448
16	keramiikkaa	247	" : 449
17	"	248	" : 450
18	"	250	" : 451
19	"	251	" : 452
20	helmi	254	" : 453
21	"	259	" : 454
22	"	257	" : 455
23	pronssikier.	253	" : 456
24	keramiikkaa	252	" : 457
25	"	252	" : 458
26	pronssikier.	253	" : 459
27	helmi	252	" : 466
28	kolmoishelmi	252	" : 461
29	keramiikkaa	254	" : 462
30	helmi (2 kpl)	254	" : 463 252
31	helmi	254	" : 464
32	keramiikkaa	253	" : 465
33	helmi	254	" : 466
34	"	258	" : 467
35	keramiikkaa	256	" : 468
36	"	253	" : 469
37	"	255	" : 470
38	helmi	258	" : 471

21 20

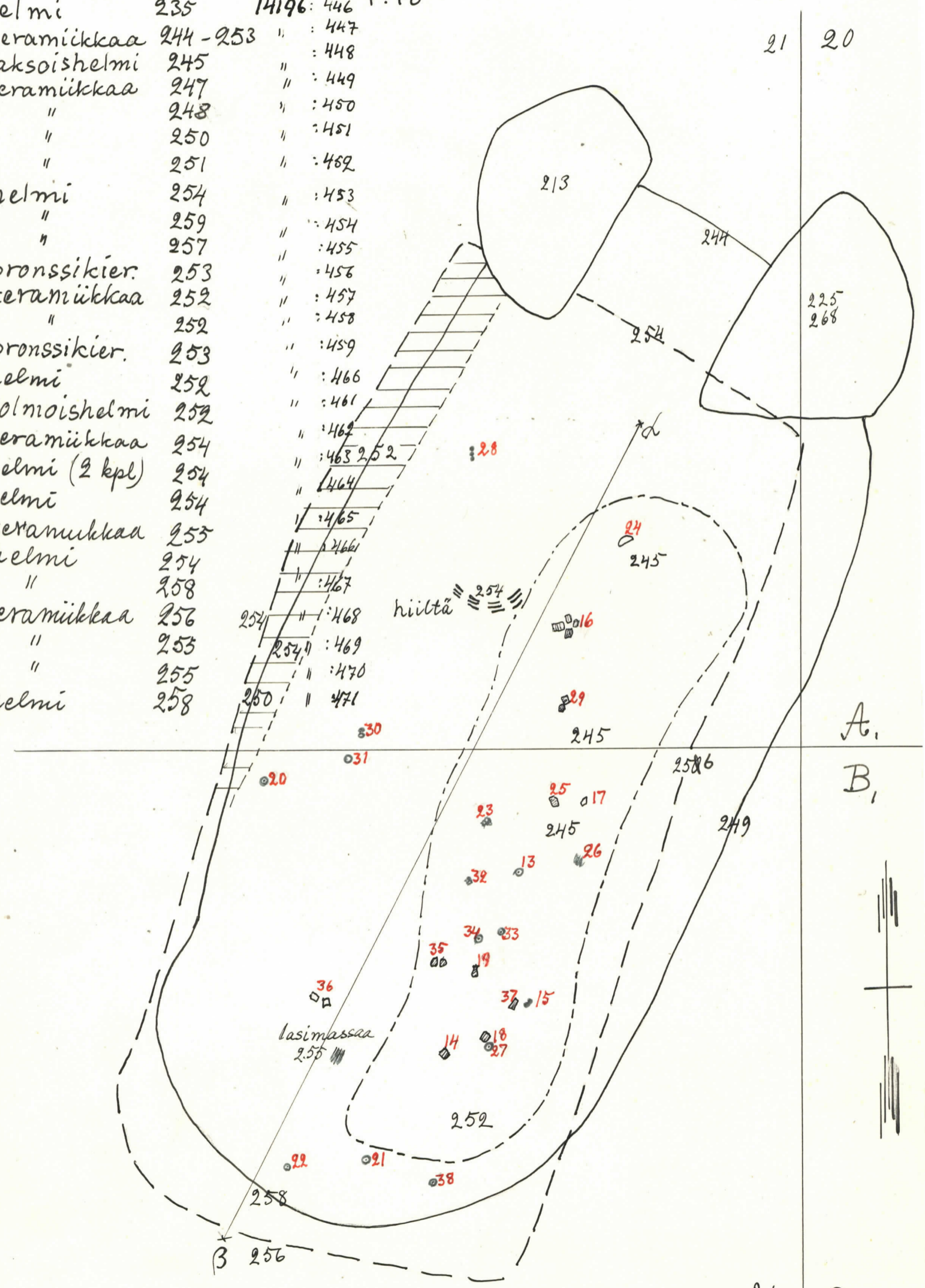

A.
B.

21 20

YLÄNE, ANIVEHMAANMÄKI

HAUTA LXXIII: 5

A-L HIRVILUOTO 1957

piirt. L-J Räsänen

1:10

39	keramiikkaa	255	14196	:472
40	"	255	"	:473
41	"	258	"	:474
42	"	258	"	:475
43	helmi	258	"	:476
44	keram.	258	"	:477
45	"	255	"	:478
46	"	258	"	:479
47	"	255	"	:480
48	"	258	"	:481
49	helmi	258	"	:482
50	keram.	258	"	:483
51	"	266	"	:484
52	"	255	"	:485
53	helmi	258	"	:486
54	"	259	"	:487
55	keram.	259	"	:488
56	helmi	253	"	:489
57	keram.	253	"	:490
58	helmi	256	"	:491
59	"	255	"	:492
60	"	255	"	:493
61	keram.	263	"	:494
62	helmi	258	"	:495
63	keram.	259	"	:496
64	"	262	"	:497
65	"	262	"	:498
66	"	259	"	:499
67	"	264	"	:500
68	"	262	"	:501
69	"	256	"	:502
70	helmi	262	"	:503
71	"	260	"	:504
72	"	258	"	:505
73	keram.	264	"	:506
74	pronssia	259	"	:507
75	katoishelmi	262	"	:508
76	keram.	262	"	:509
77	"	260	"	:510
78	"	263	"	:511
79	"	258	"	:512
80	"	262	"	:513
81	"	264	"	:514
82	"	264	"	:515
83	rikkon. helmi	264	"	:516

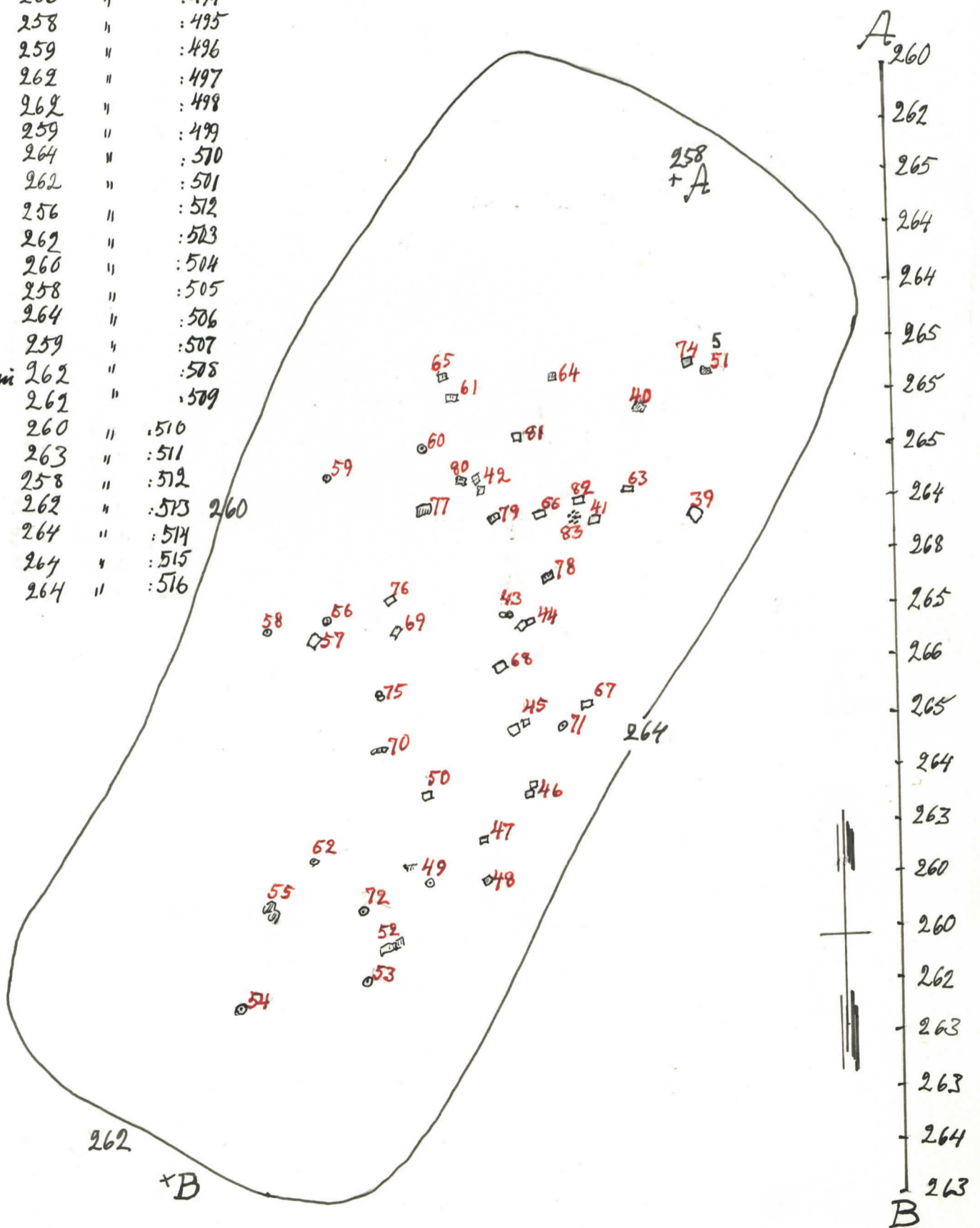

YLÄNE, ANIVEHMAANMÄKI
HAUTA LXXIII, Profiili
L-1 RÄSÄNEN 1:10
A-L Hirviluodon kaivaus 1957

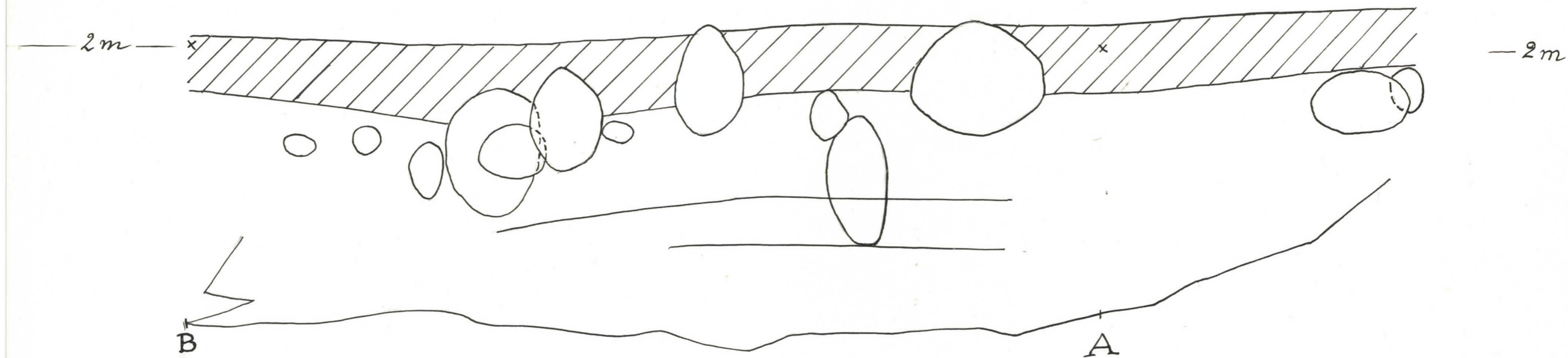

YLÄNE, ANIVEHMAANMÄKI

HAUTA LXXIV:1

A-L Hirviluoto 1957,

piirt. Paavo Huovari

1:10

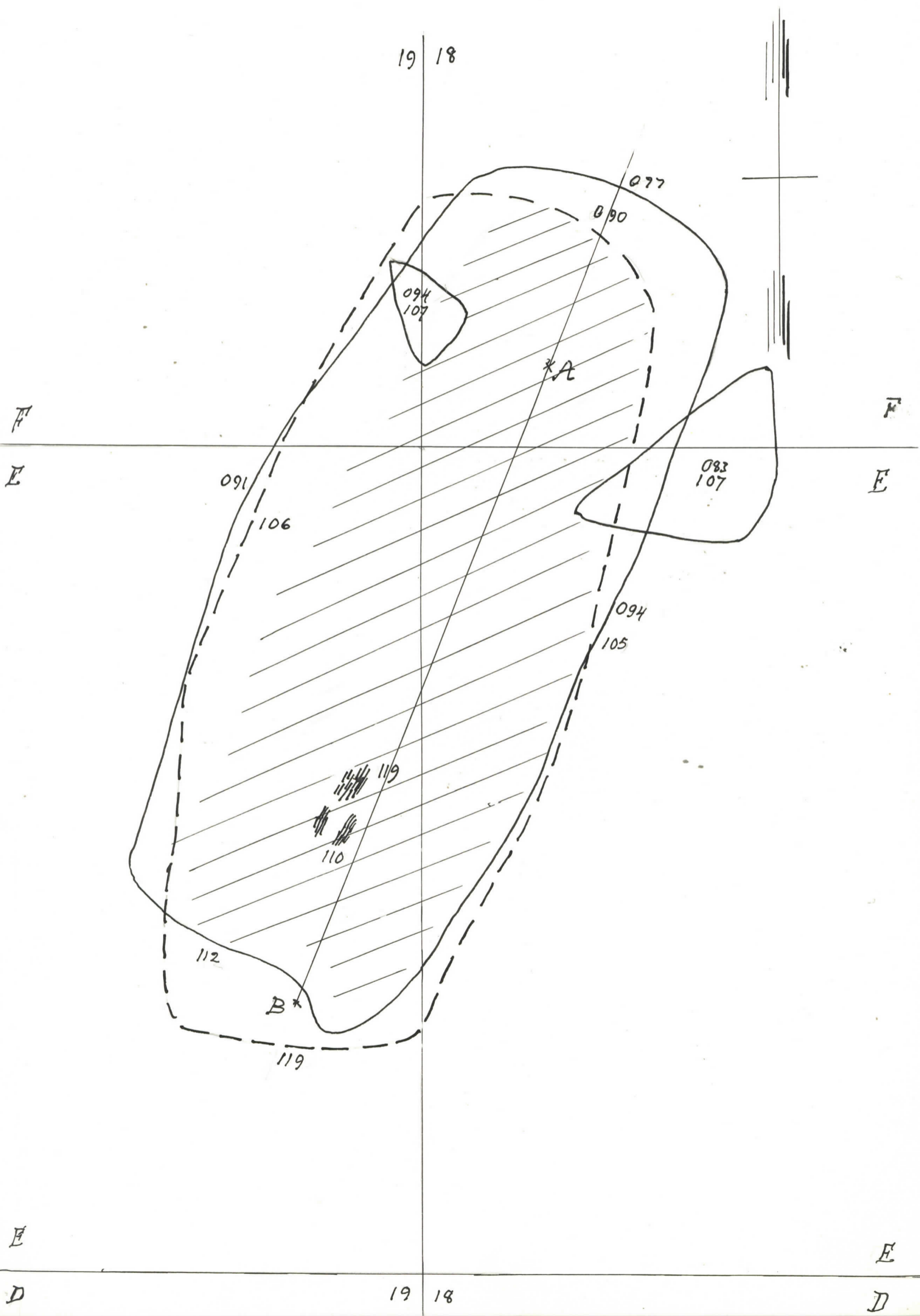

YLÄNE, ANIVEHMAANMÄKI
HAUTA LXXIV: 2
A-L Hirviluoto 1957
piirt Paavo Huovari
1:10

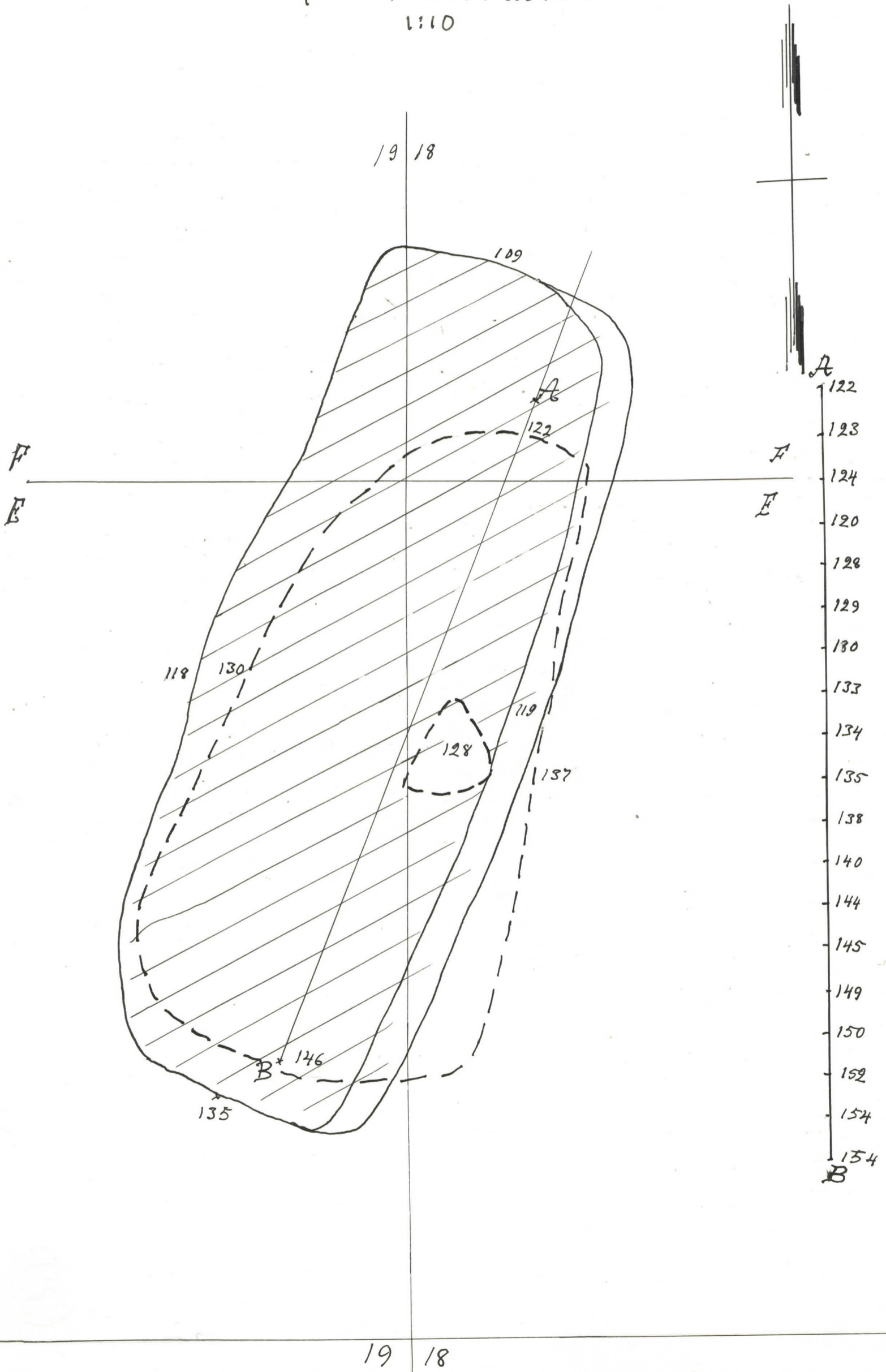

YLÄNE, ANIVEHMAANMÄKI
HAUTA LXXIV
PROFILLI
A-L Hirsiluoto 1957
piirt. L-J Räsänen

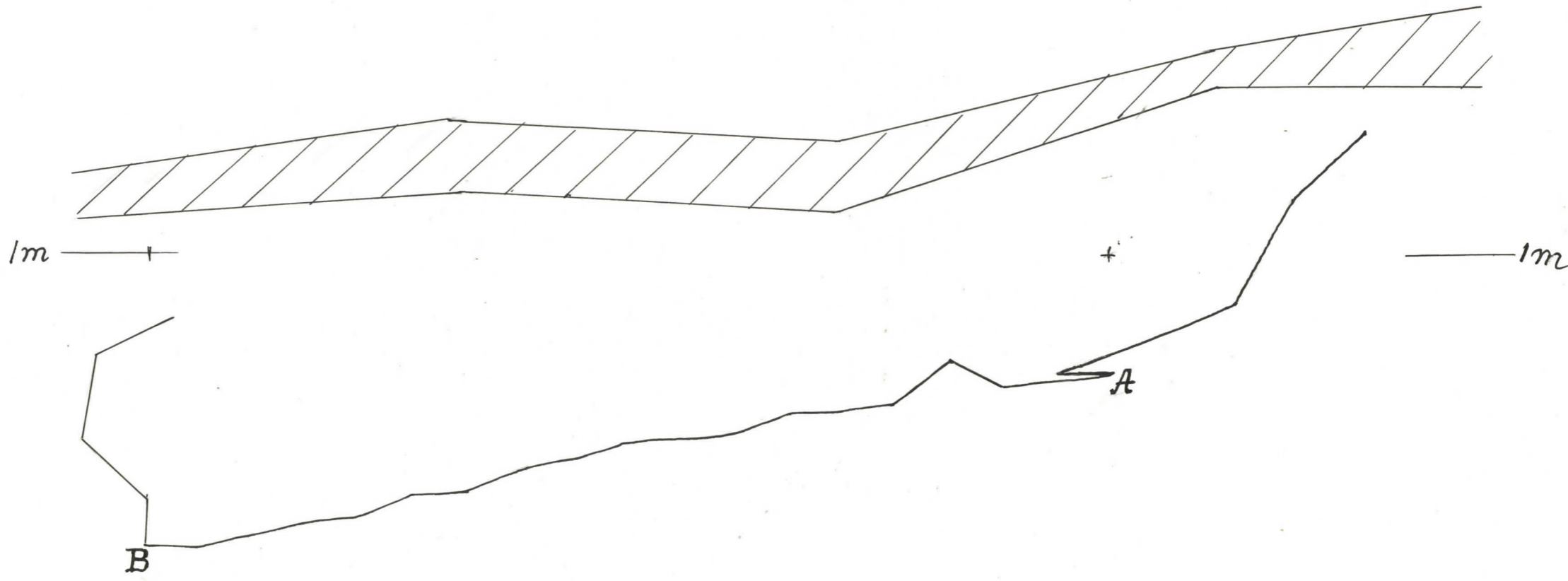

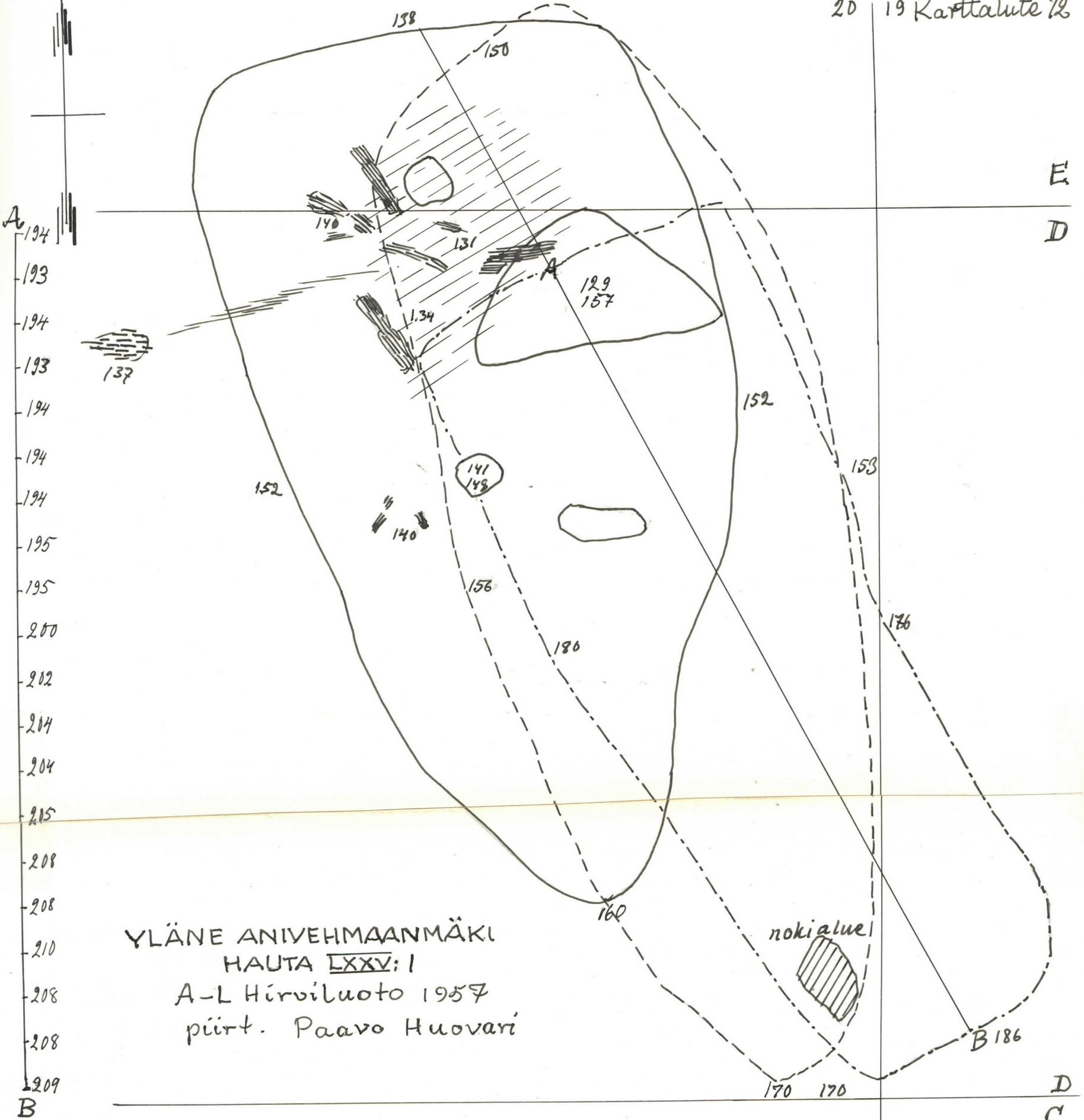

YLÄNE ANIVEHMAANMÄKI
 HAUTA LXXV:1
 A-L Hirviluoto 1957
 piirt. Paavo Huovari

Profili, 1:10
 L-J Räsänen

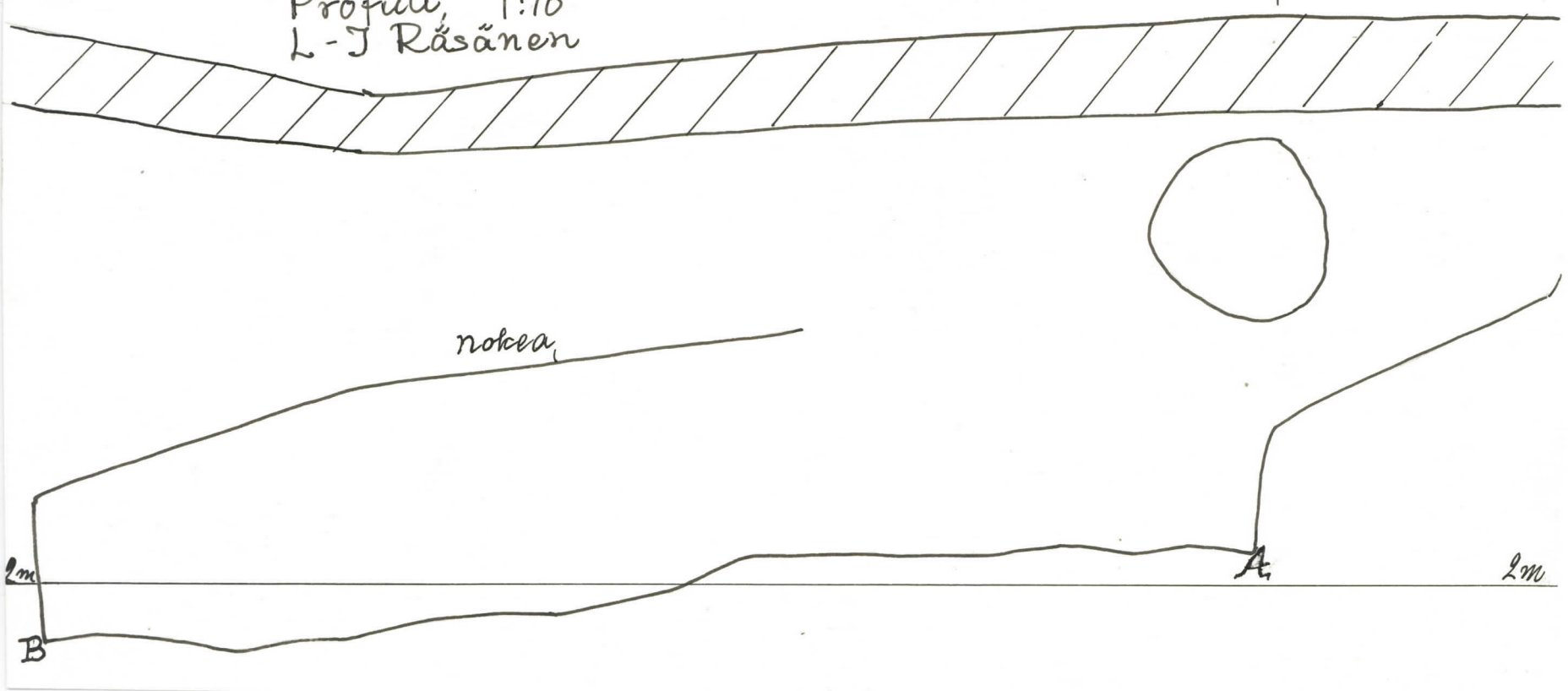

YLÄNE, ANIVEHMAANMÄKI
HAUTA LXXVI:1
AL Hirviluoto 1957
piirt. P. Huovari
1:10

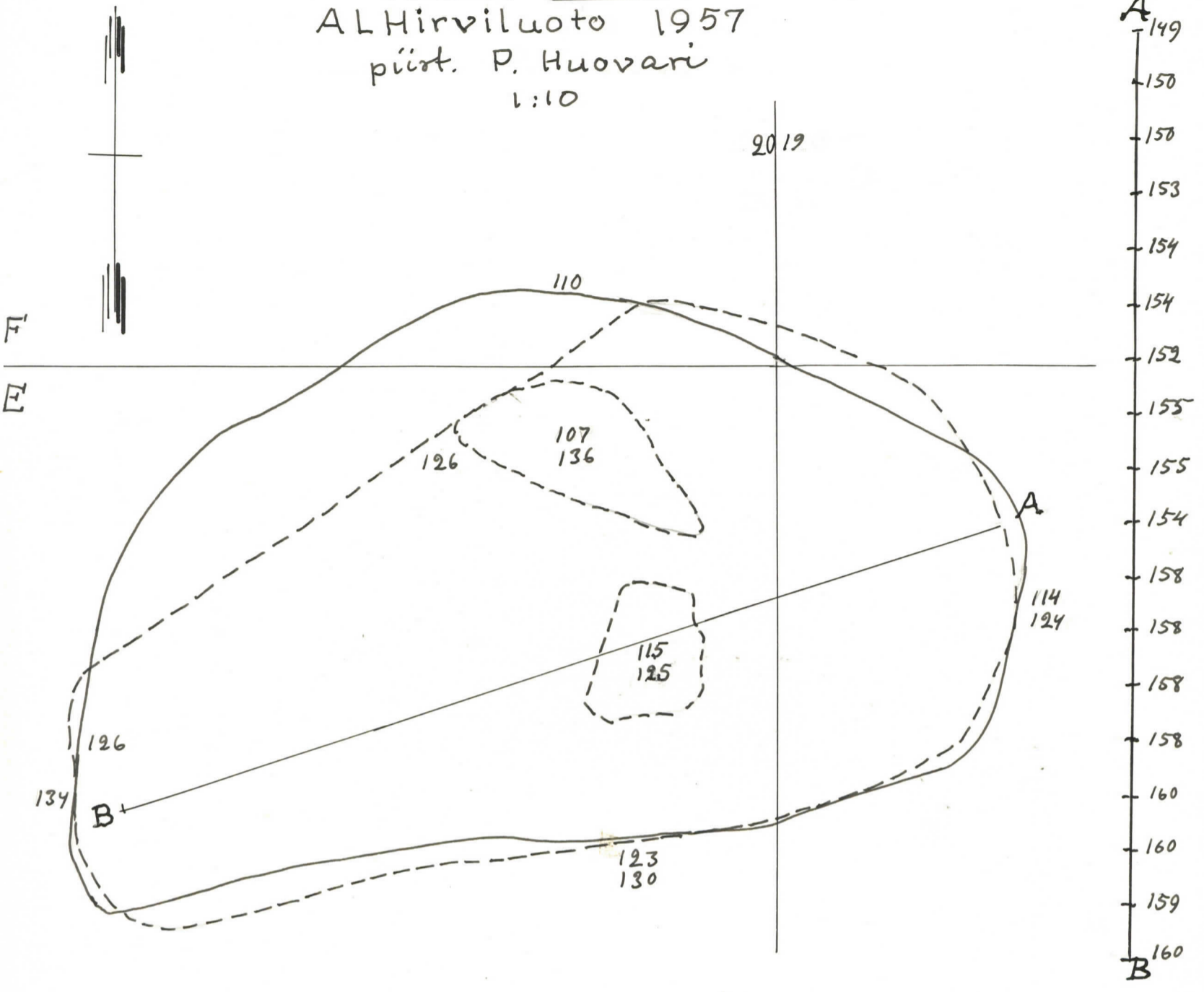

Profüli
piirt L-J Räsänen
1:10

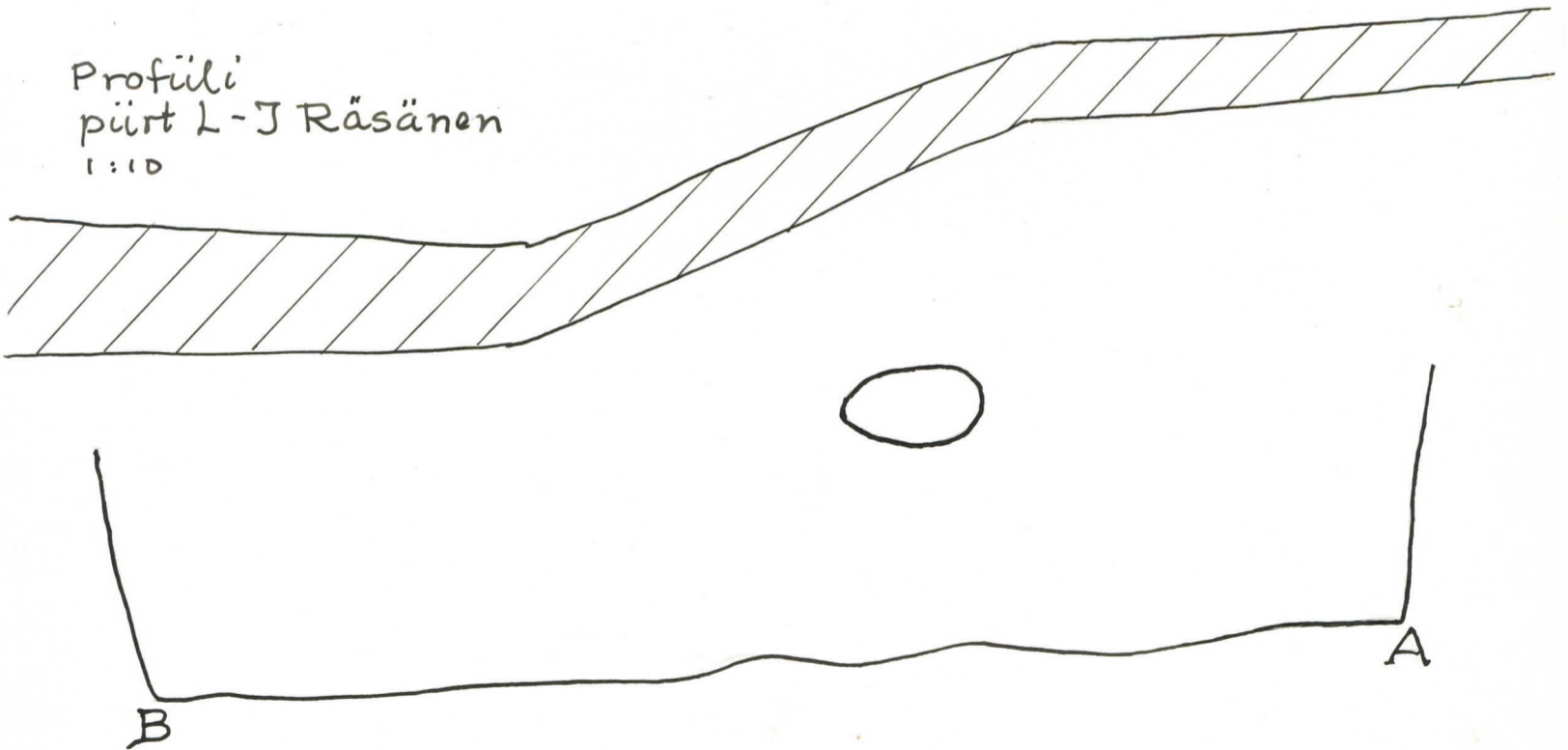

- 1 veitsi 224 14196 : 519
- 2 sormus 228 " : 520
- 3 kopeea 238 " : 521

YLÄNE, ANIVEHMAANMÄKI
 HAUTA LXXVII:1
 A-L Hirviluoto 1957
 piirt, Paavo Huovari
 1:10

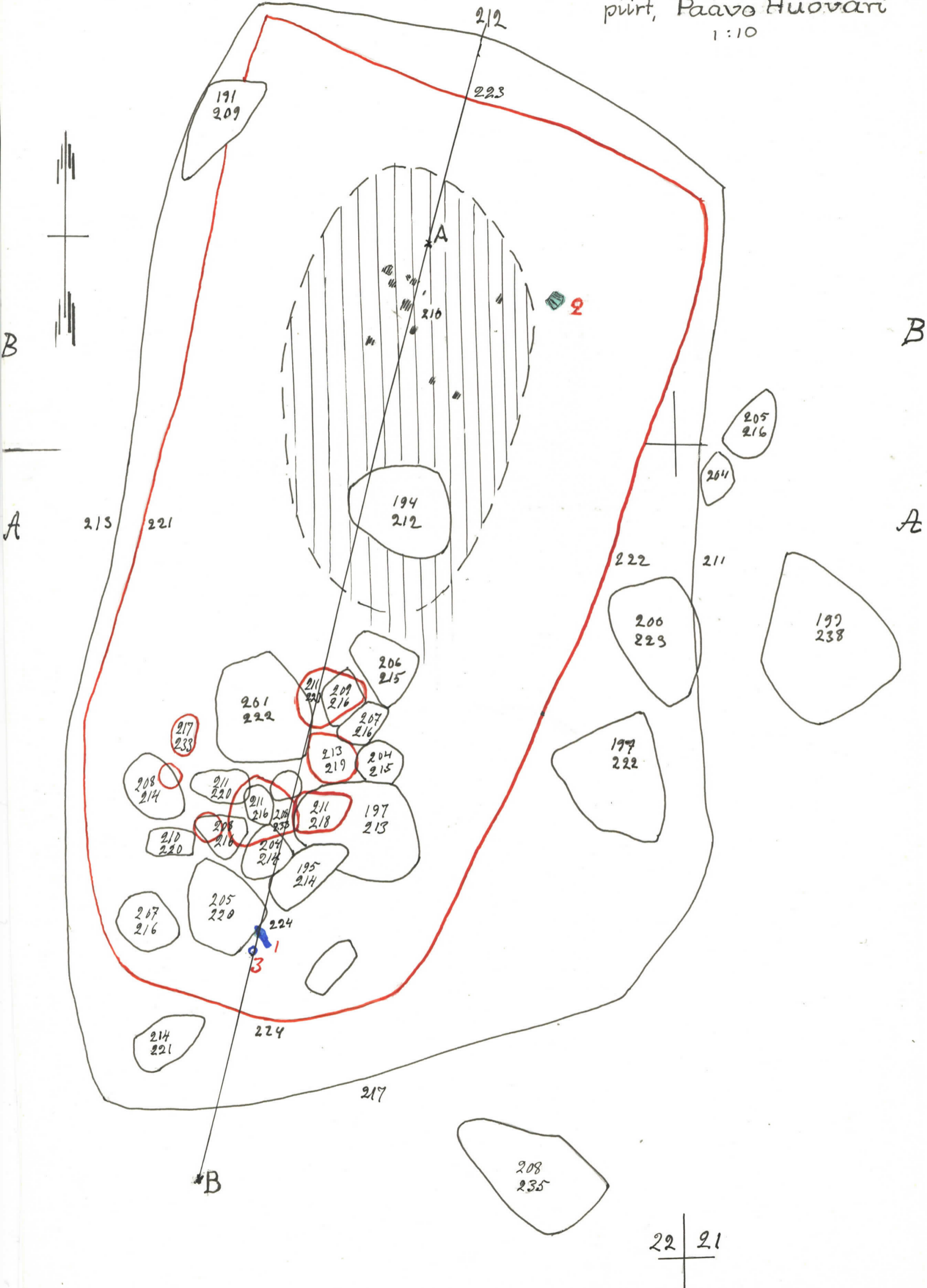

22 | 21

YLÄNE, ANIVEHMAANMÄKI

HAUTA LXXVII:2
 A-L Hirviluoto 1957
 piirt. Paavo Huovari
 1:10

- 4 saviastia 238-248 14196: 522
- 5 pr. rengas 235 : 523
- 6₁ ja 6₂ keihäänk. 241-242 : 524, 525
- 7 saviastia 241-251 : 526
- 8 solki 243 : 527
- 9 rautanauha 242 : 528
- 10 rautaa 242 : 529
- 11 solki 247 : 530
- 12 pr. rengas 248 : 531

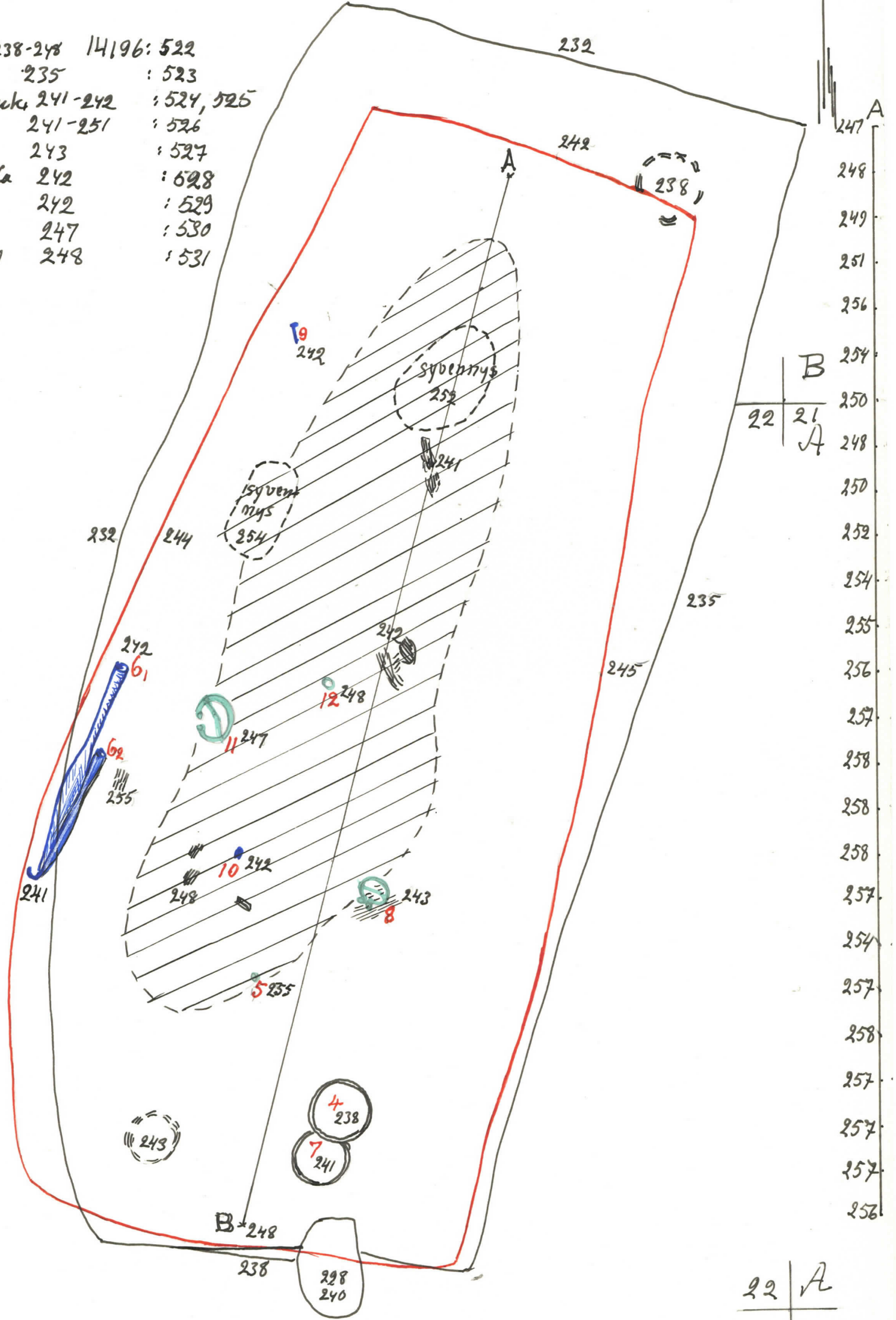

23 | 22

22 | 21
 A

23 | 22

22 | A
 A,

1m

YLÄNE, ANIVEHMAANMÄKI
HAUTA LVIII; profiili b.
A-LHIRVILUOTO 1957
piirt. L-I Räsänen
1:10

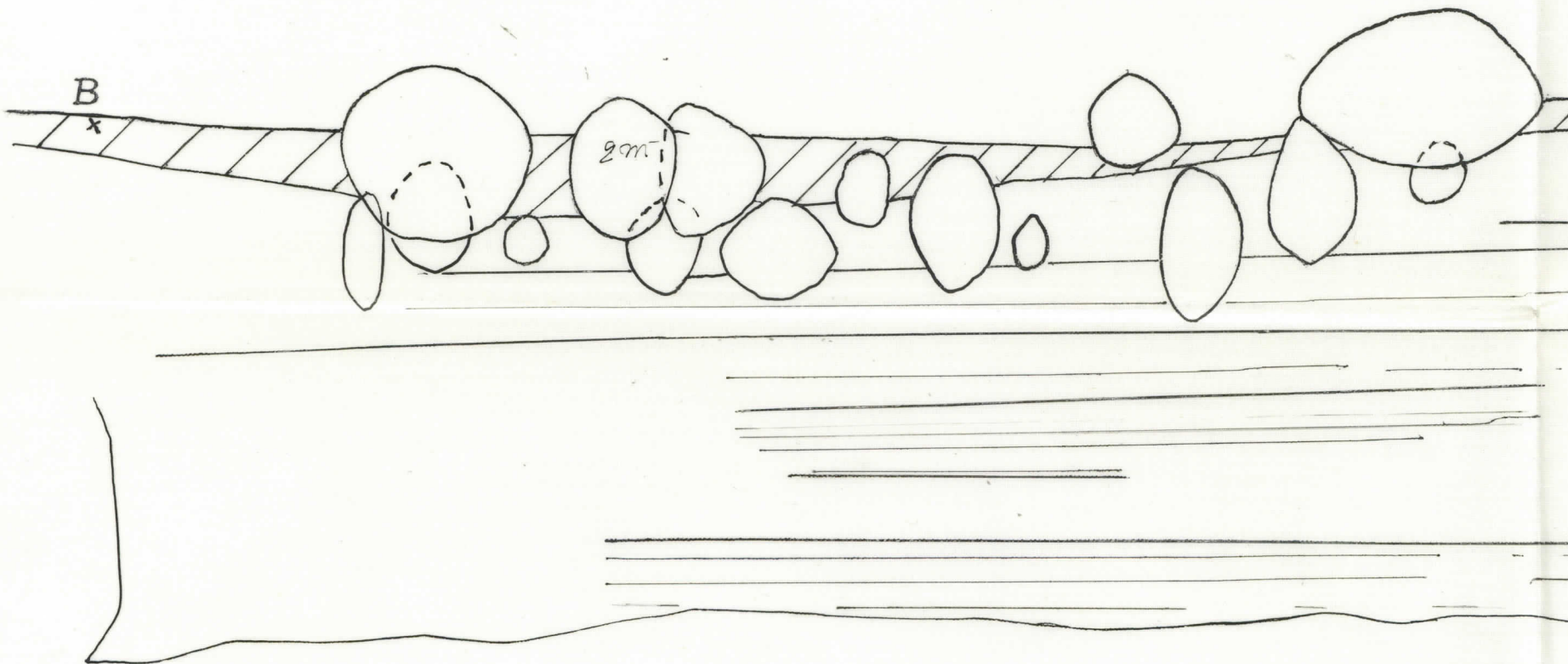

3m

1m

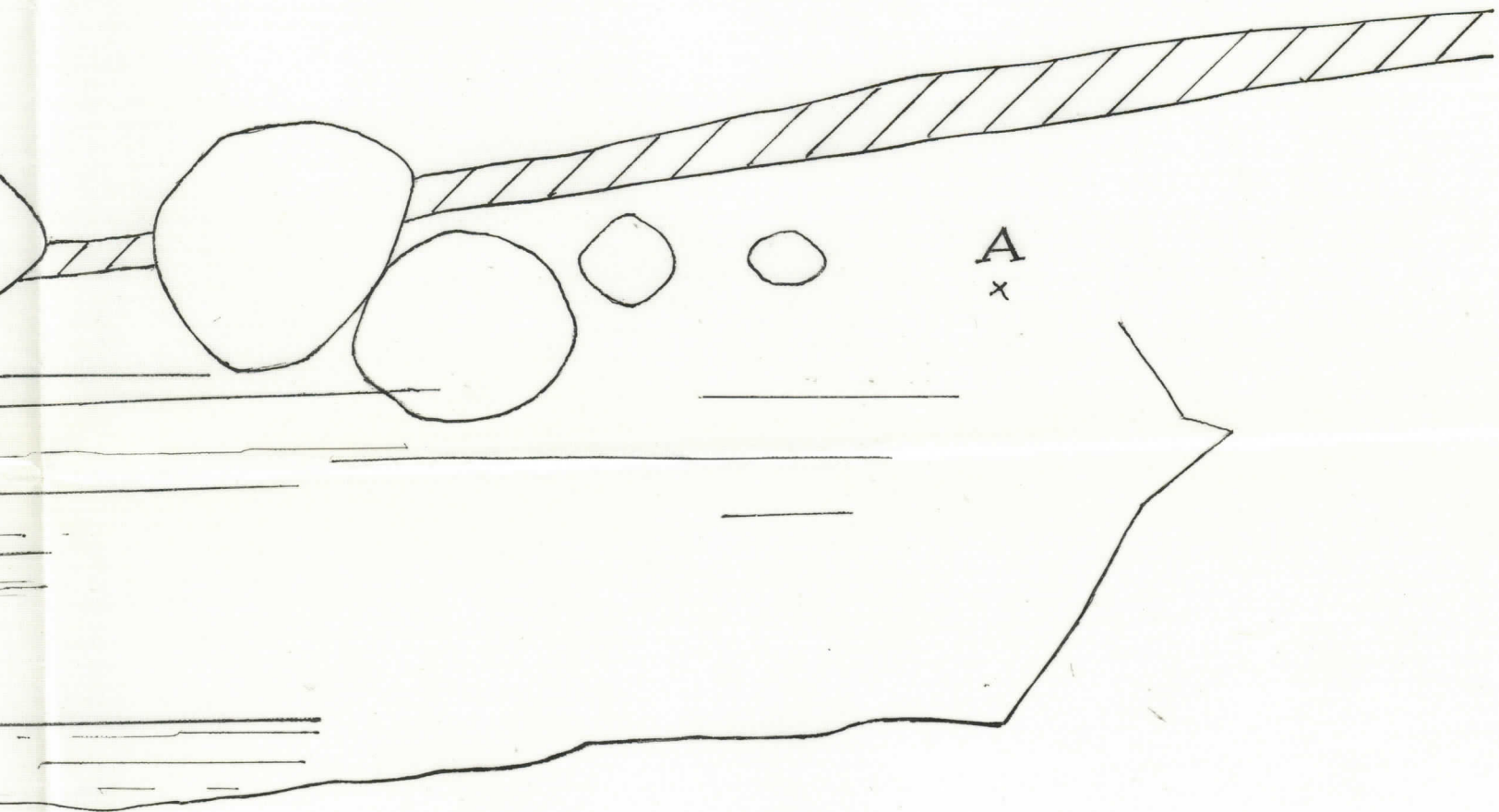

—

2m

—

3m

14196	: 535	4	helmiä	230
"	: 536	5	helmi	210
"	: 537	6	"	225
"	: 538	7	"	225
"	: 539, 540	8	"	225
"	: 541	9	"	238
"	: 542	10	"	234
"	: 543	11	"	235
"	: 544	12	"	235
"	: 545	13	"	234
"	: 546	14	puukko	230
"	: 547	15	rannerengas	233
"	: 549	16	rannerengas	236
"	: 552	20	sosnus	234
"	:	23	helmiä (2 kpl)	
"	:	24	helmi	
"	: 553	25	solki	
"	: 558	26	kaularengas	
"	: 567	27	solki	
"	: 571	28	puuta ym.	
"	: 572	29	puuta ym.	
"	: 573	30	pronssia	230
"	: 574	31	rautaa	234
"	: 575	32	tekstiiliä	225
"	: 576	33	tekstiiliä	232
"	: 577	34	tekstiiliä	231
"	: 578	35	helmi	239
"	: 579	36	helmi (luu)	239
"	: 580	37	"	239
"	: 581	38	helmiä (7 kpl)	233
"	: 582	39	helmi	234
"	: 583	40	"	238
"	: 584	41	"	236
"	: 585	42	"	"
"	: 586	43	"	"
"	: 587	44	"	"
"	: 588	45	"	"
"	: 589	46	"	"
"	: 590	47	"	"
"	: 591	48	"	234
"	: 592	49	"	"
"	: 593	50	"	"
"	: 596	51	"	"
"	: 594	52	"	"
"	: 595	53	"	"
"	:	54	pronssirengas	240
"	: 559	55	tekstiiliä päärenkaan alta	240
"	: 597	56	helmiä päärenkaan sisältä	240
"	: 598	57	kuukelmi	240
"	: 599	58	rautarengas	235
"	: 600	59	tekstiiliä	240
"	: 560	60	tekstiiliä päärenkaan alta	
"	: 565	61	tekstiiliä päärenkaan päältä	238
"	: 561	62	luuta	238
"	: 564	63	tekstiiliä päärenkaan alta	238
"	: 562	64	tekstiiliä päärenkaan ja soljin 25 alta	238
"	: 601	65	ketjua	240
"	: 603	66	tunmaa massaa	242
"	: 604	67	tasavartinen solki	236
"	: 605	68	sininen helmi	240
"	: 609	73	"	240
"	:	74	tekstiiliä kaularenkaan alta	
"	:	75	tuohia	
"	: 563	76	tekstiiliä nauhaa	
"	: 606	69	helmi	240
"	: 607	70	"	"
"	: 608	72	"	"
"	: 609	73	"	"

YLÄNE, ANIVEHMAANMÄKI

HAUTA LXXVIII: 2
A-L Hirviluoto 1957
pürt. L-J Räsänen
1:10

- 1 helmi 205 14196 : 532
- 2 keramiikkaa 215 " : 533
- 3 sirppi 215-221 " : 534

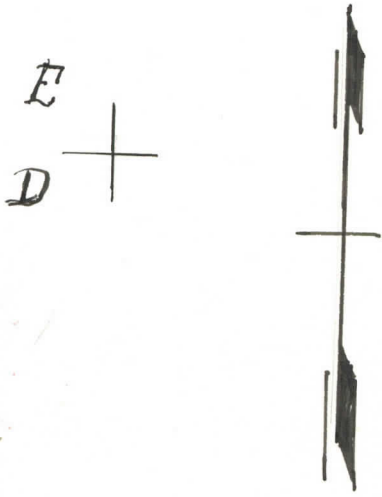

 1. kerroksen nokea

 2. kerroksen nokea

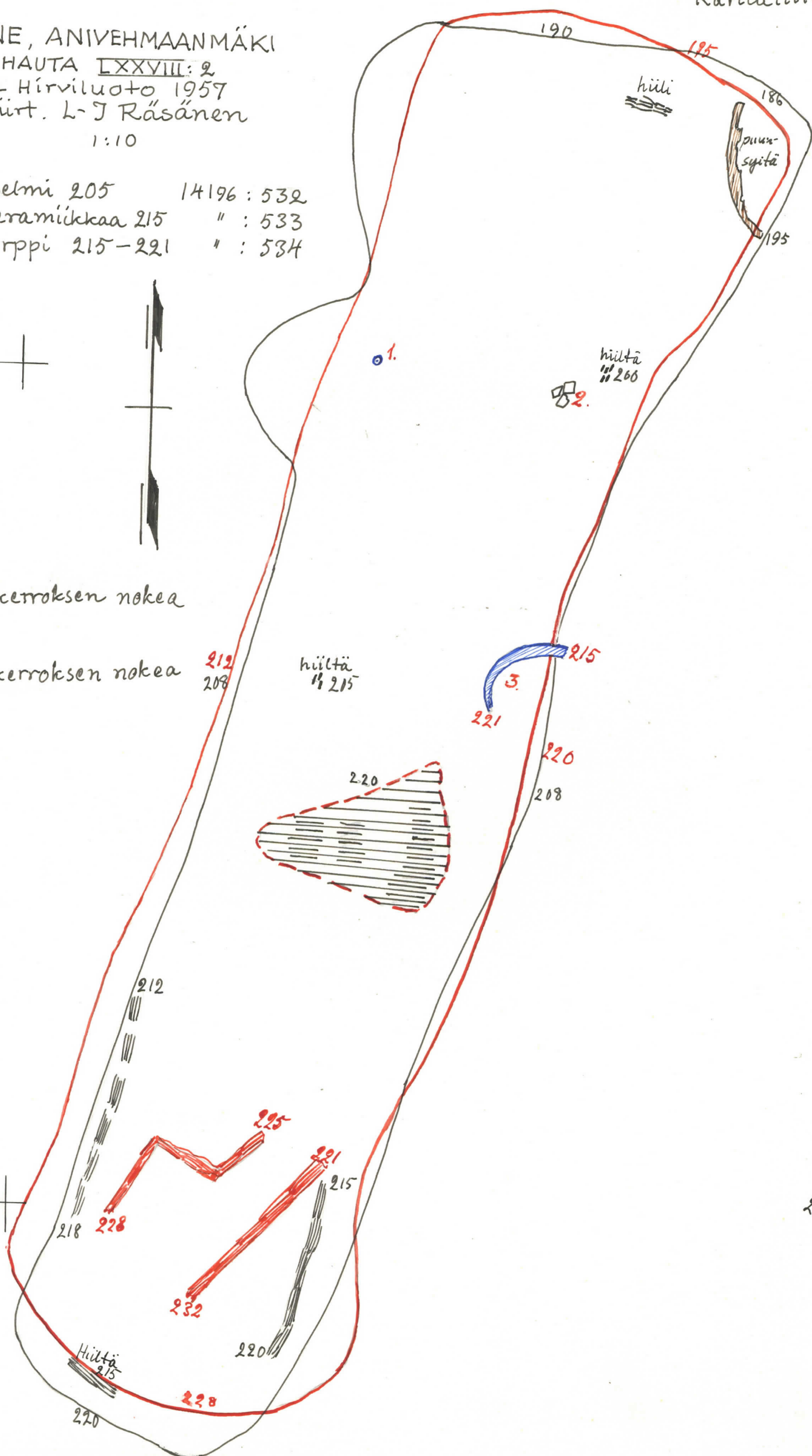

23

23

YLÄNE, ANIVEHMAANMÄKI
HAUTA LXXIX:1
A-L Hirviluoto 1957
piirt Paavo Huovari
1:10

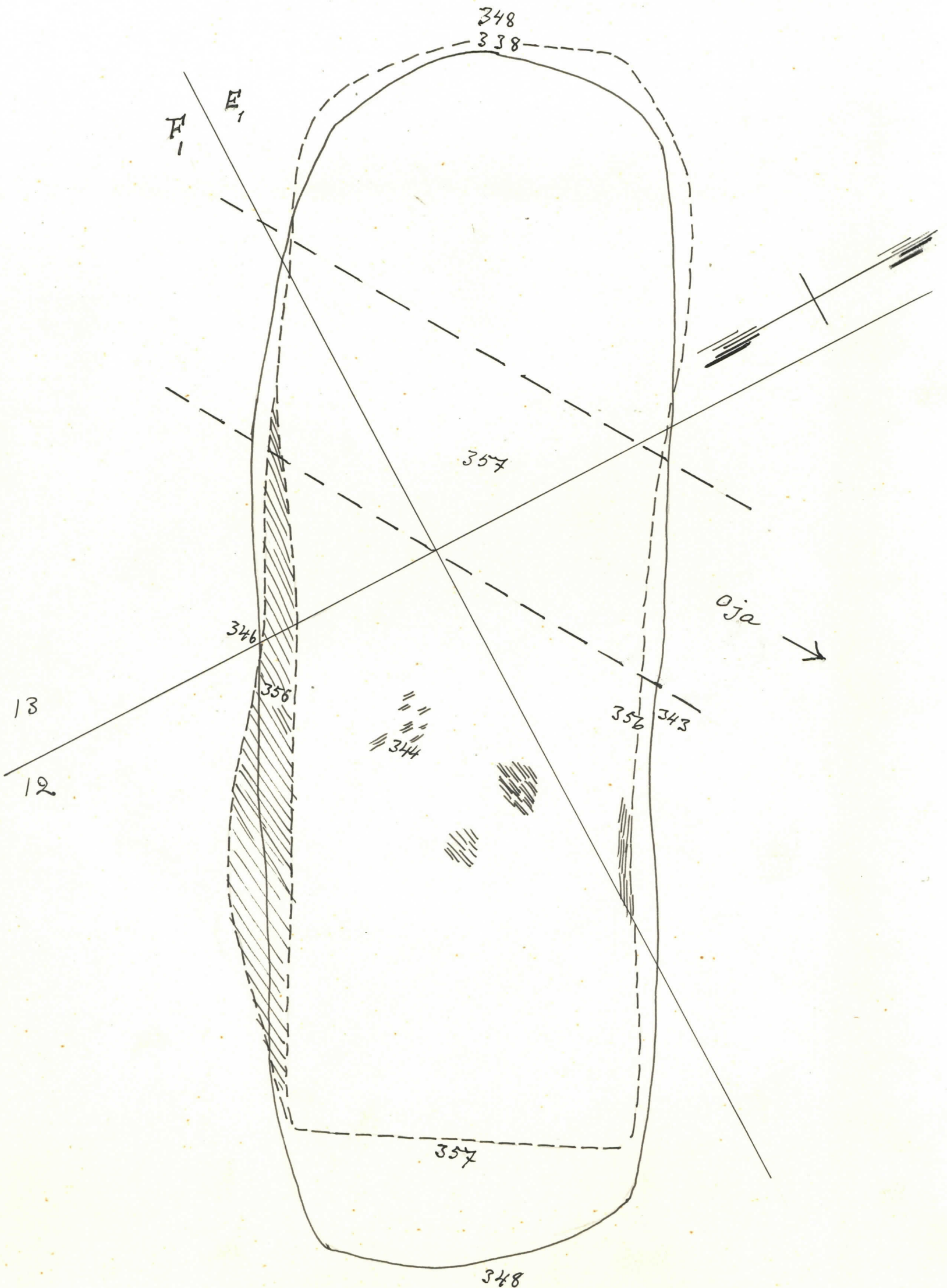

1	helmi	357	14196:615
2	rautaa	358	:616
3	solki	358	:617
4	pronssia	363	:618
5	saviastia	357	:619
6	solki	364	:620
7	helmi	370	:621
8	"	370	:622
9	"	374	:623
10	rautaa	371	:624
11	pronssia	366	:625,626
12	rautaa	367	:627
13	pronssia	367 (acroleiilla)	:628
14	"	368	:629
15	"	379	:630
16	"	368	:631
17	rautaa	368	:632
18	pronssia	368	:633
19	"	368	:634
20	rautaa	372	:635
21	helmi	378	:636

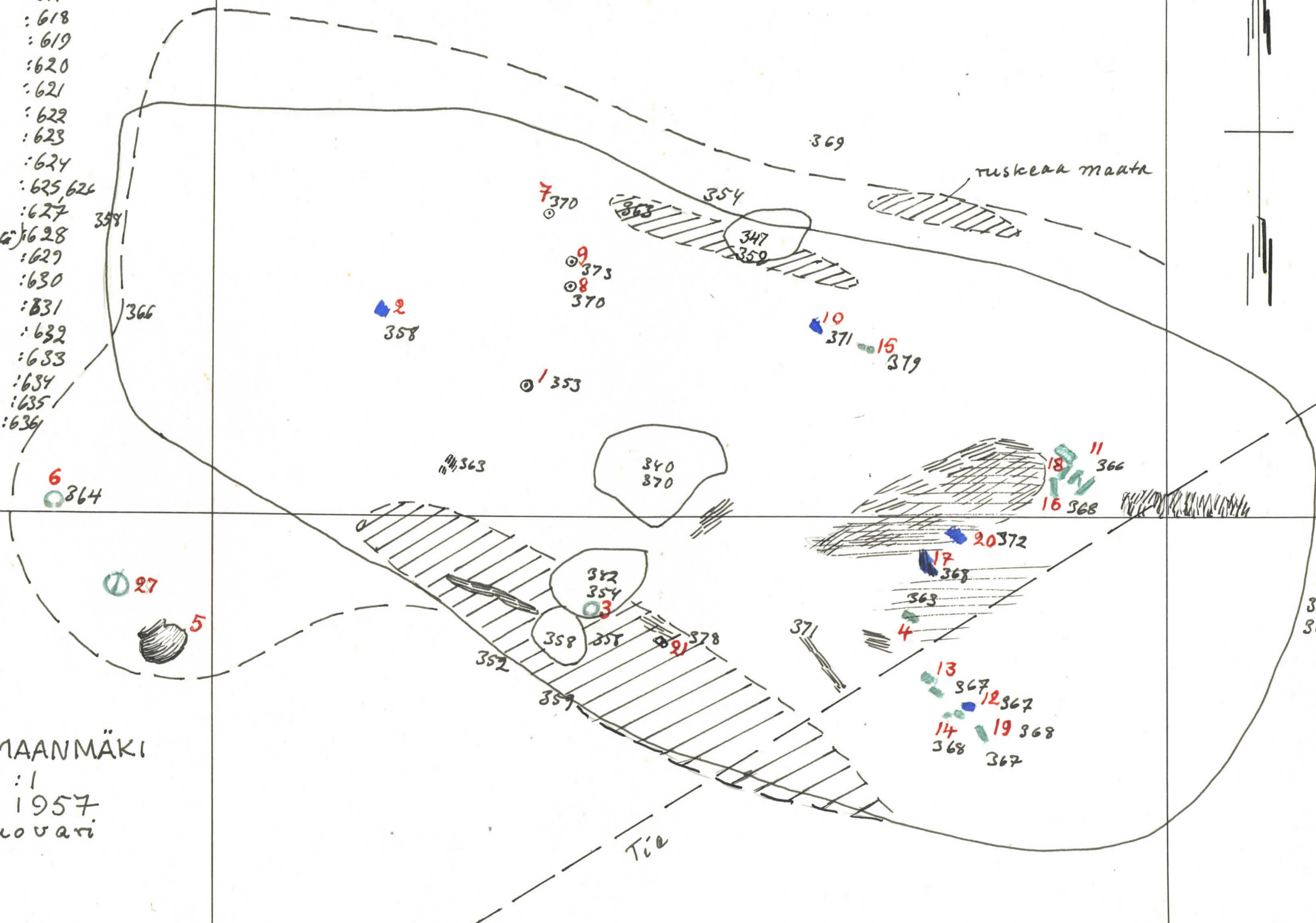

YLÄNE, ANIVEHMAANMÄKI
 HAUTA LXXX : I
 A-L Hirviluoto 1957
 piirt Paavo Huovari
 1:10

14

13

13

12 Karttaliite 84 A

378

378

379

379

380

380

382

383

383

384

382

381

382

384

384

383

384

384

384

382

381

377

YLÄNE, ANIVEHMAANMÄKI

HAUTA LXXX:2

A-L Hirviluoto 1957

piirt. Paavo Huovari

1:10

377

A

386

Ruskeaa
maata

384

F₁G₁

22	pronssia	377
23	helmi	383
24	tekstiilia	379 (päällä tuokta)
25	" "	381
26	pronssirengas	381
27	solki	362

14196: 637

: 638

: 639

: 641

: 643

: 644

karttal. 83

383

383
23

377

22

25

381

379

24

26

381

B

376

B

1. rautaa 14196-645

YLÄNE, ANIVEHMAANMAKI
HAUTA XXXI,
A-L Hirvikuoto 1957
piirt. P. Huovari
1:10

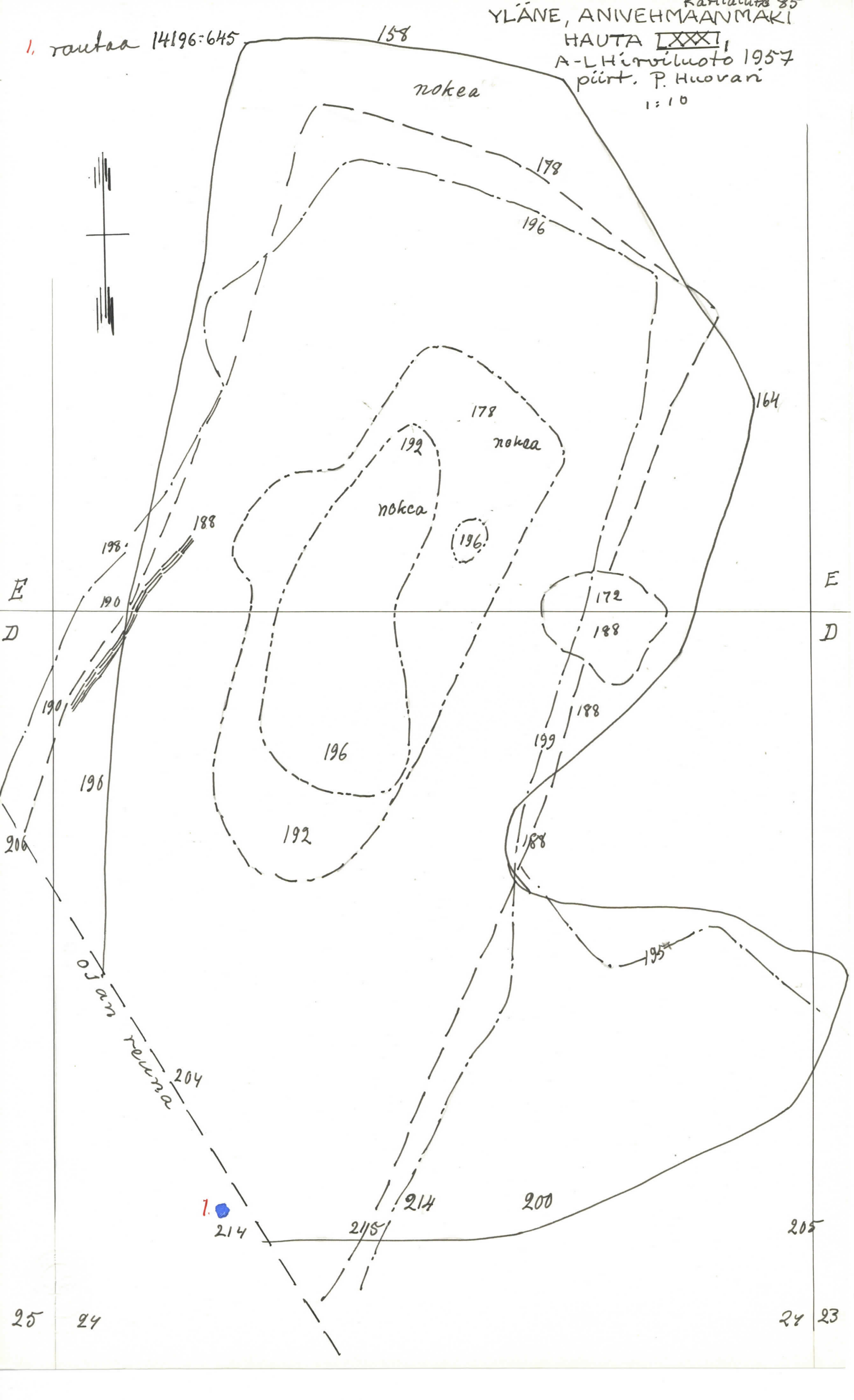

E
D

E
D

25 24

24 23

YLÄNE, ANIVEHMAANMÄKI

HAUTA LXXXI 2

A-L Hirviluoto 1957
piirt. L-I Räsänen

1:10

2	miekka	212-219	14196: 646
3	keihäänk.	215-219	: 647
4	keihäänk.	194-202	: 648
5	sormus	205	: 649
6	sormus	218	: 650
7	rautaa	223	: 651
8	"	218	: 652
9	"	212	: 653
10	"	212	: 654

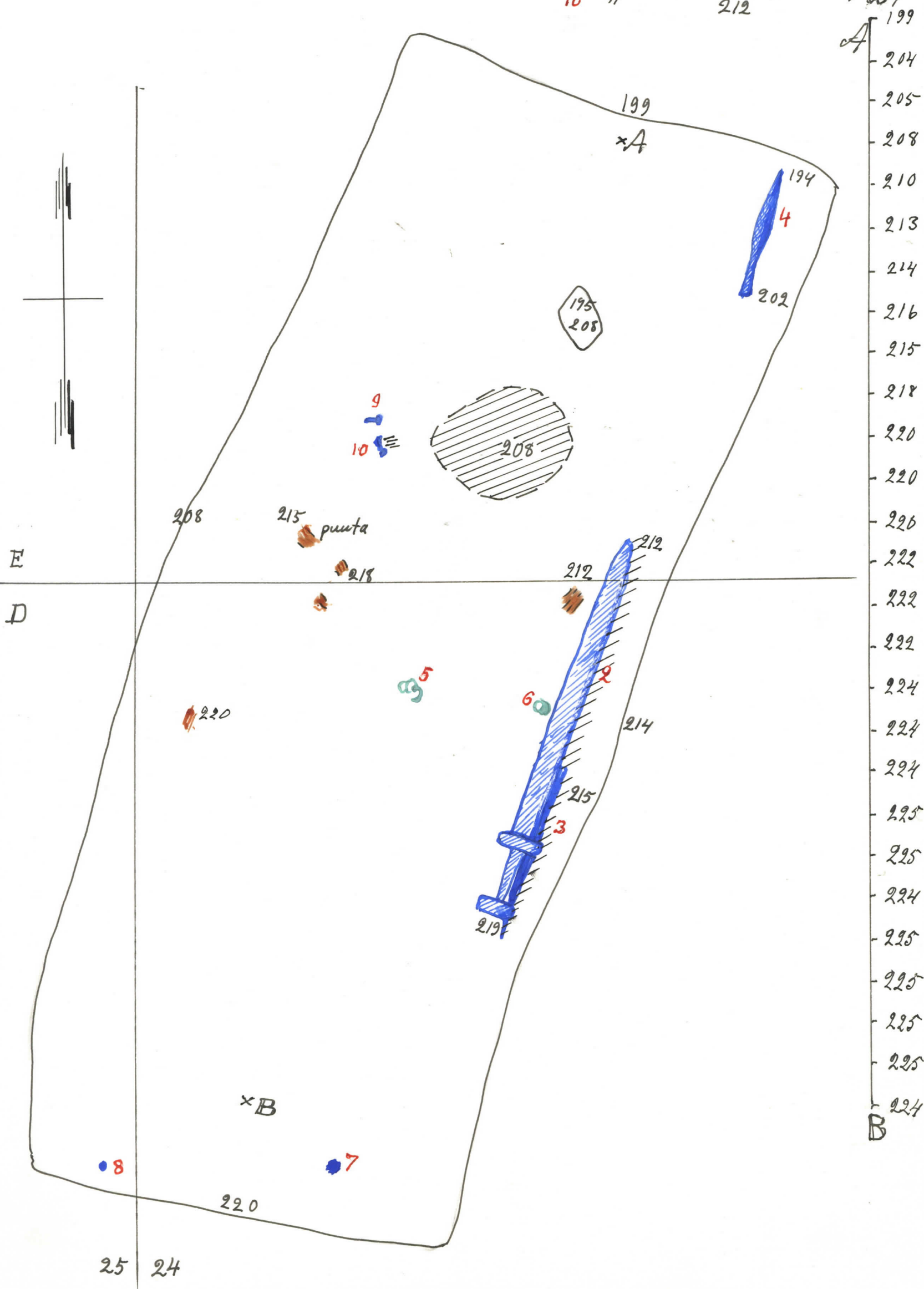

25 24

YLÄNE, ANIVEHMAANMÄKI
 HAUTA, LXXXII :1
 A-L Hirsiluoto 1957
 piirt. Paavo Huovari
 1:10

1	rautaa	252	14196	: 656
2	veitsi	353		: 657
3	r-naula	352		: 658
4	helmi	356		: 659
5	solki (päälle tek.)	354		: 660
6	" " +rautaa	349		: 661
7	hopearaha	352		: 664
8	helmi	352		: 665
9	"	352		: 666
10	"	352		: 667
11	"	352		: 668
12	"	352		: 669
13	"	352		: 670
14	"	352		: 671
15	"	352		: 672
16	"	352		: 673
17	"	352		: 674
18	"	352		: 675
19	"	353		: 676
20	"	351		: 677
21	"	350		: 678
22	"	351		: 679
23	Sirppi	362		: 680

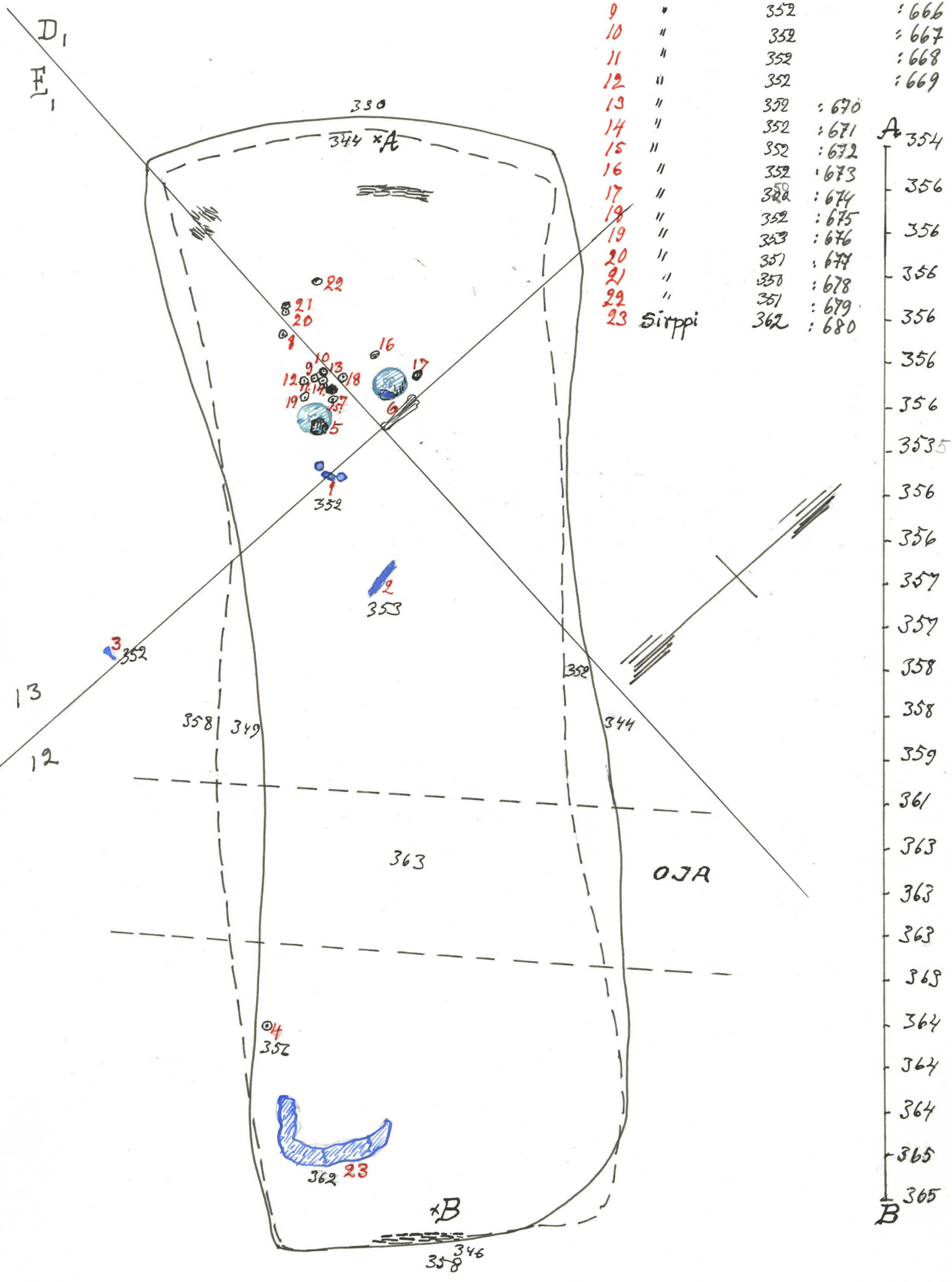

YLÄNE, ANIVEHMAANMÄKI
HAUTA LXXXIII:1

A-L Hirviluoto 1957
piirt. Paavo Huovari
1:10

1	helmi	347	14196: 681
2	saviast. pala	338	: 682
3	"	350	: 683
4	"	345	: 684
5	"	348	: 685
6	"	350	: 687
7	"	350	: 688
8	veitsi	354	: 689
9	saviast. pala	350	: 690
10	" "	349	: 691
11	" "	351	: 692
12	" "	351	: 693
13	" "	350	: 694
14	helmi	368	: 695
15	saviast. pala	362	: 696
16	" "	365	: 697
17	" "	363	: 698

C₁
D₁

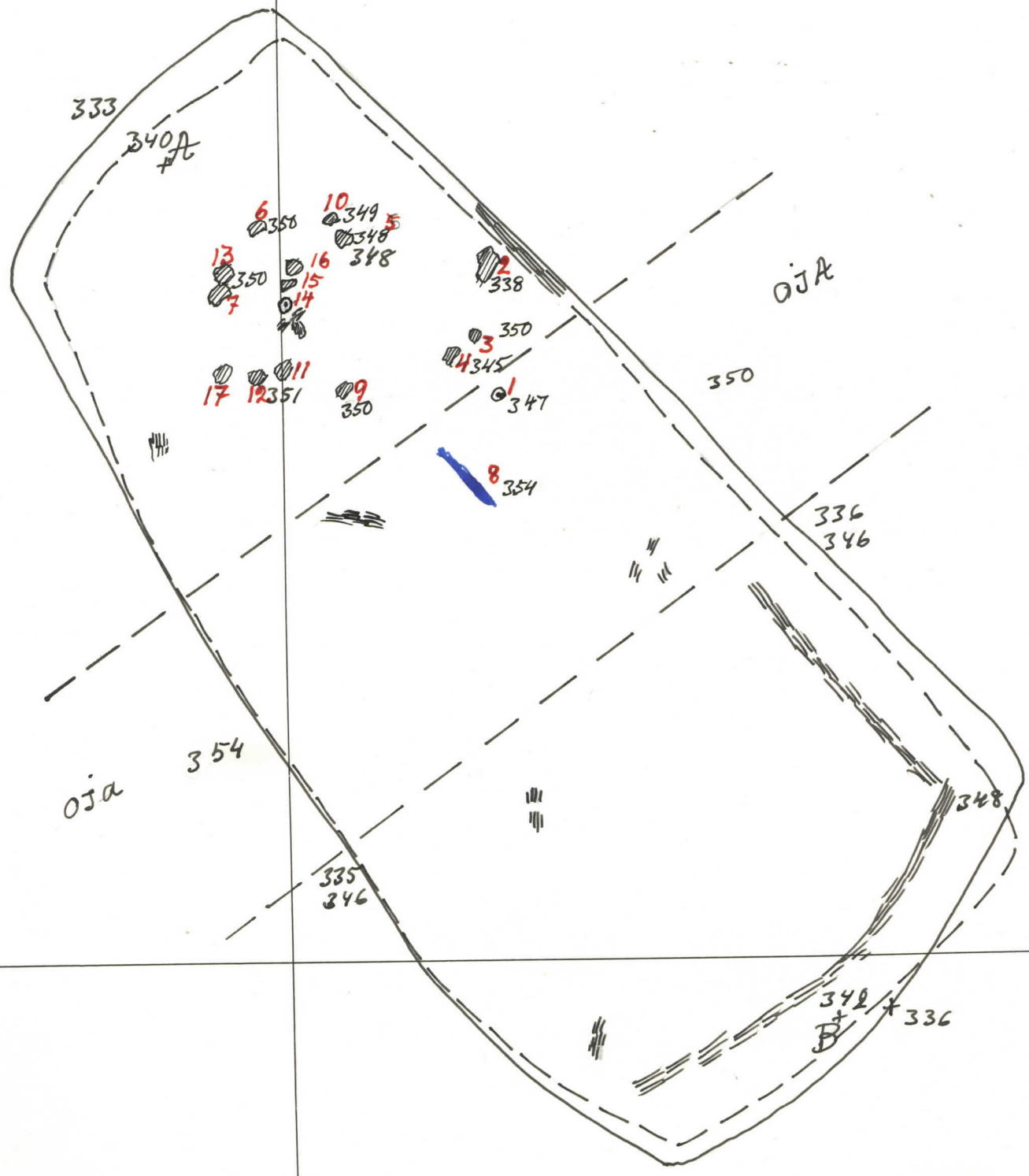
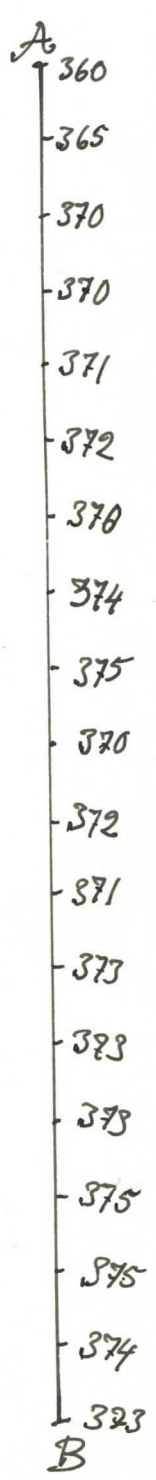

D₁
E₁

12 11

YLÄNE, ANIVEHMAANMÄKI
NUOTIO?
A-L Hirviluoto 1957
L-J Räsänen
1:10

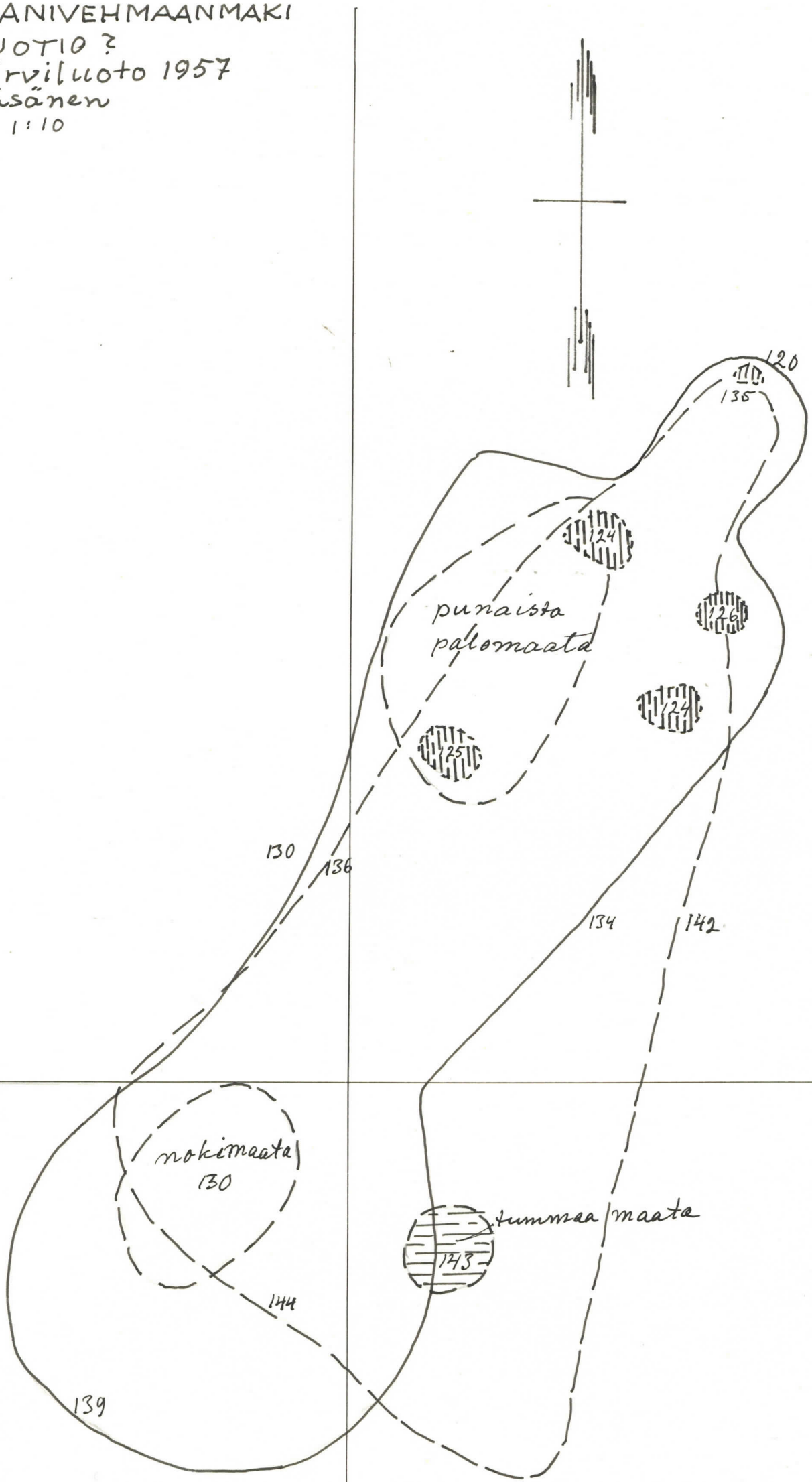

25 24