

VANTAA LÄNSISALMI 2002
Gubbäcka ja Labben

Pk 2043 07

Peruskartta 1:20 000
PerusCD 2002

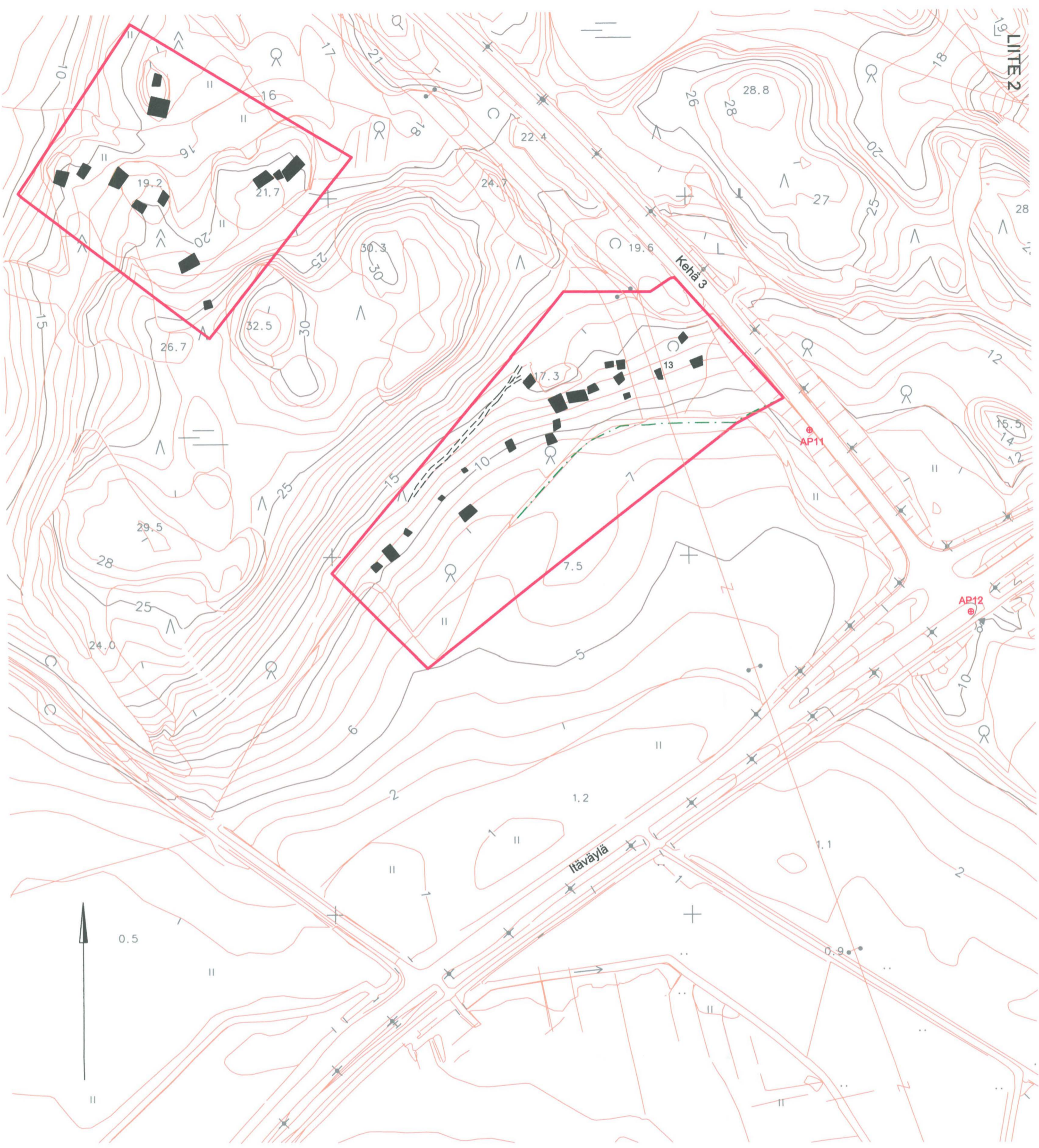

- Rakennuksen pohja
- Pellonreuna
- Vanha tienpohja
- Muinaisjäännösalueen raja
- ⊕ AP11 X=682069,013 Y=563668,521 Z=13.132
- ⊕ AP12 X=681967,391 Y=563757,729 Z=9.884



<p>VANTAA, LÄNSISALMI Gubbacka 2002</p> <p>V.-P. Suhonen</p>	<p>Yleiskartta Mk 1:2000</p> <p>(Pohjakartta Uudenmaan tiepiiri)</p>
<p>MITTAUSDOKUMENTOINTI</p> <p>Donald Lillqvist, Riina Mäki V.- P. Suhonen</p> <p>Puht. piirt. Päivi Hakanpää</p>	<p>MUSEOVARASTO, RAKENNUSHISTORIAN OSASTON ARKISTO HELSINKI</p>
<p>Liite 2</p>	

29.5

17.3

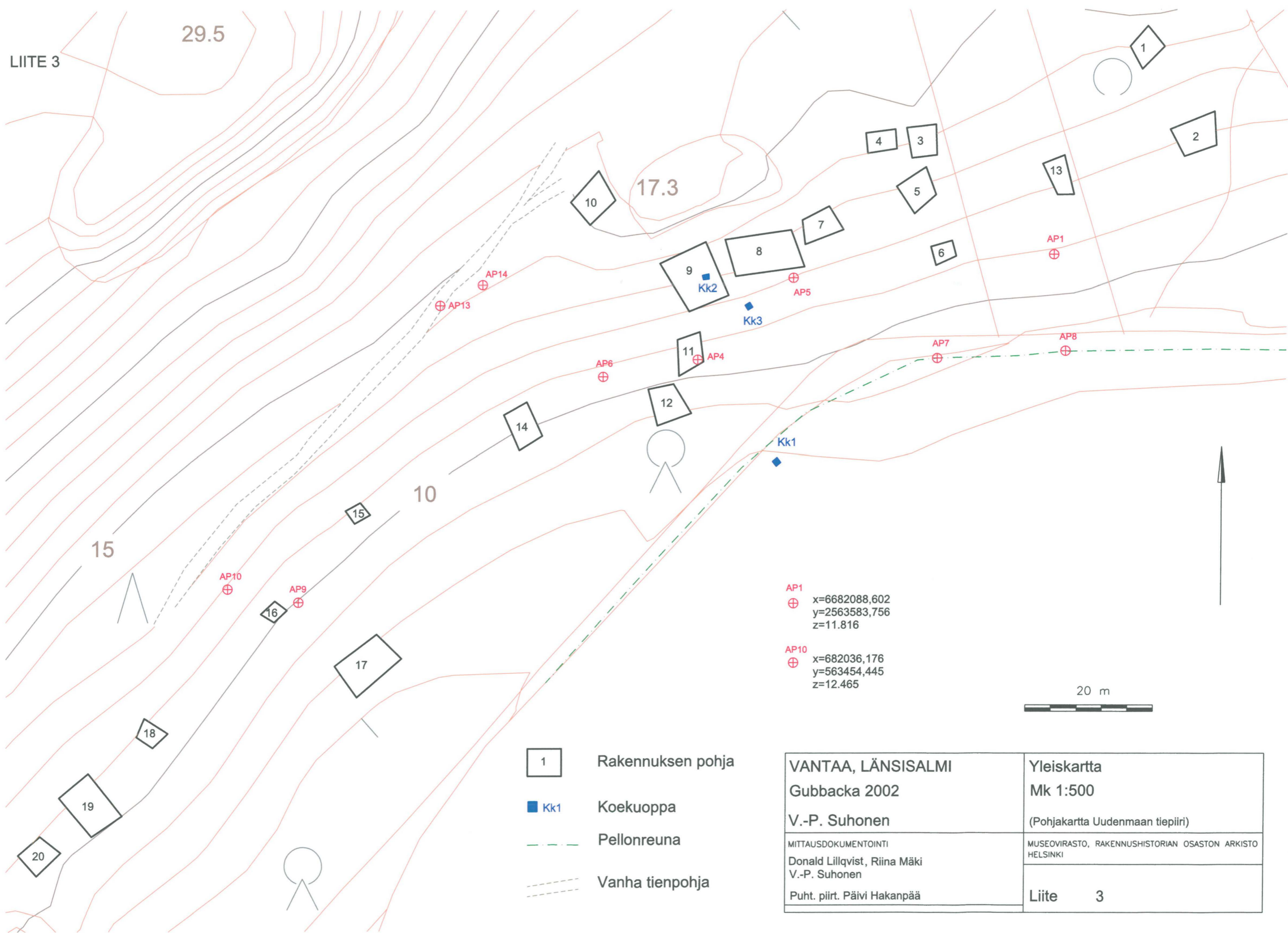

AP1
⊕ x=6682088,602
y=2563583,756
z=11.816

AP10
⊕ x=682036,176
y=563454,445
z=12.465



- 1 Rakennuksen pohja
- Kk1 Koekuoppa
- Pellonreuna
- Vanha tienpohja

VANTAA, LÄNSISALMI Gubbacka 2002 V.-P. Suhonen		Yleiskartta Mk 1:500 (Pohjakartta Uudenmaan tiepiiri)
MITTAUSDOKUMENTOINTI Donald Lillqvist, Riina Mäki V.-P. Suhonen Puht. piirt. Päivi Hakanpää		MUSEOVIRASTO, RAKENNUSHISTORIAN OSASTON ARKISTO HELSINKI
		Liite 3

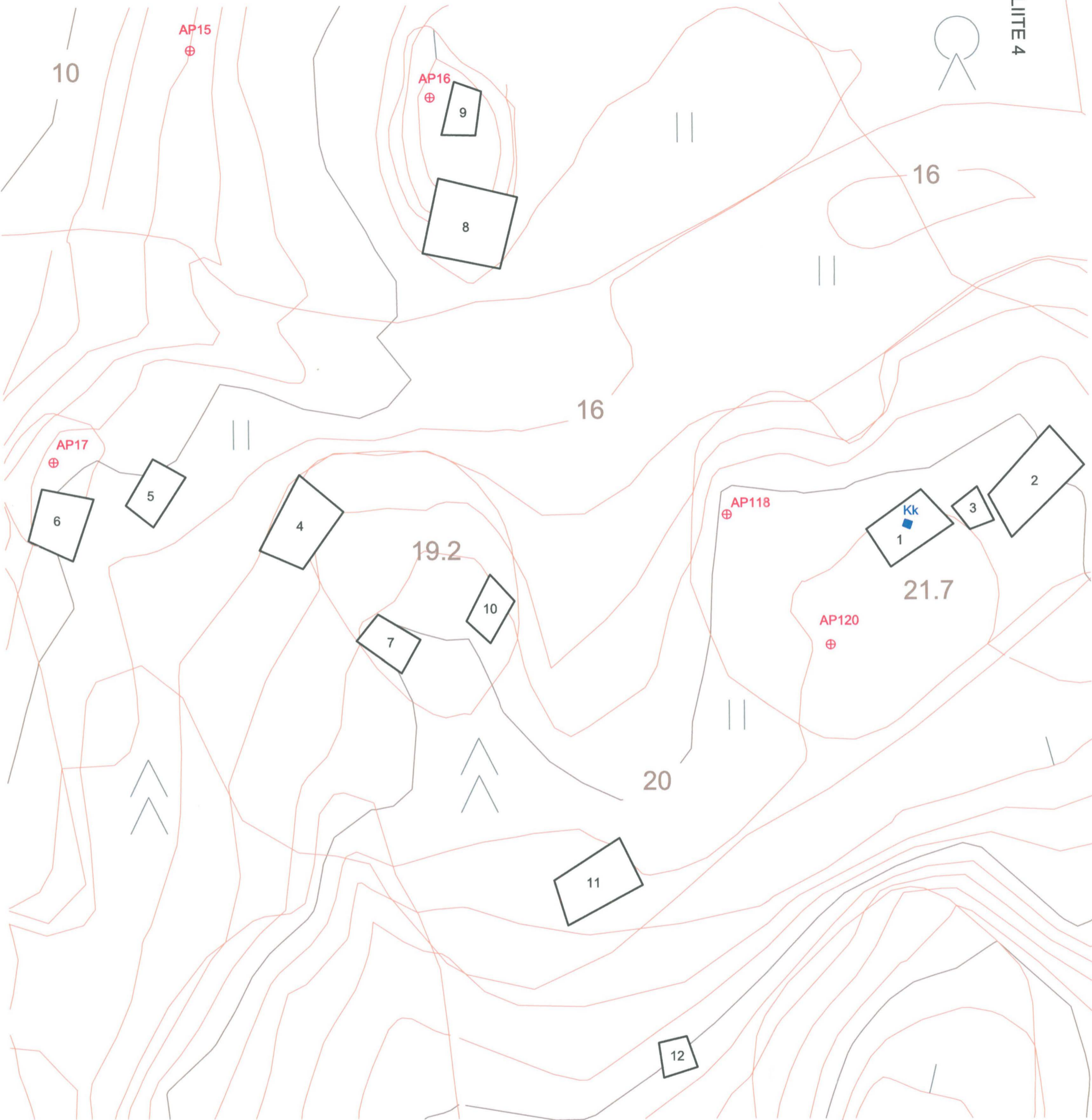

Rakennuksen pohja



Koekuoppa



AP15 X=682275,355 Y=563268,574 Z=13.88
 AP16 X=682268,893 Y=563300,438 Z=18.759
 AP17 X=682220,679 Y=563249,776 Z=15.092
 AP118 X=682213,233 Y=563339,434 Z=20.796
 AP120 X=682195,908 Y=563353,100 Z=21.186

VANTAA, LÄNSISALMI Labben 2002 V.-P. Suhonen		Yleikartta Mk 1:500 (Pohjakartta Uudenmaan tiepiiri)
MITTAUSDOKUMENTOINTI Donald Lillqvist V.-P. Suhonen Puht. piirt. Päivi Hakanpää		MUSEOVIRASTO, RAKENNUSHISTORIAN OSASTON ARKISTO HELSINKI
		Liite 4

Autiotontit ja muinaisjäännökset

LIITE 5

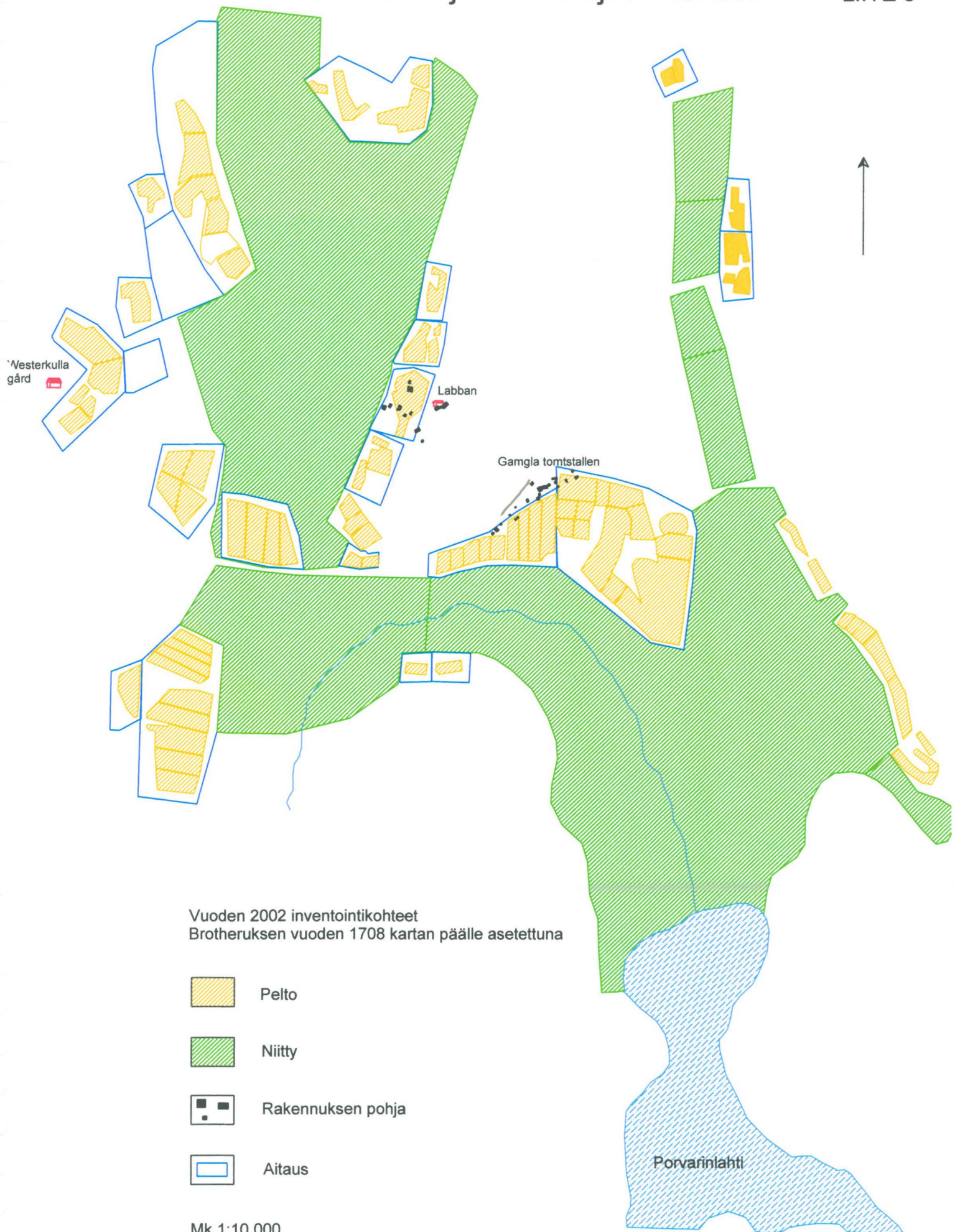

Länsisalmen vanha kylätontti



Karttapohjana on käytetty Westermarkin & Bonejin isojakokarttaa vuosilta 1763-1767

Karttaan on merkitty vuoden 2002 inventoinnissa löytyneet rakennuksen pohjat

Mk 1:3000

LIITE 6

Länsisalmi, Gubbacka.

Diakuvat 2002

MV/RHO 125244

Alanumero	Kohde	Aihe	Suunta	Vuosi	Kuvaaja
1	Gubbacka	Vestersundomin kyläalue kuvattuna Vuosaaren tekomäeltä.	S	2002	VPS
2	Gubbacka	Vestersundomin kyläalue kuvattuna Vuosaaren tekomäeltä	S	2002	VPS
3	Gubbacka	Vestersundomin kyläalue kuvattuna Vuosaaren tekomäeltä	S	2002	VPS
4	Gubbacka	Vestersundomin kyläalue kuvattuna Vuosaaren tekomäeltä	S	2002	VPS
5	Gubbacka	Kylätontti pellolta kuvattuna	S	2002	VPS
6	Gubbacka	Rakennus G1	SE	2002	VPS
7	Gubbacka	Rakennus G1	SW	2002	VPS
8	Gubbacka	Rakennus G1	SW	2002	VPS
9	Gubbacka	Rakennus G2	E	2002	VPS
10	Gubbacka	Rakennus G2	NE	2002	VPS
11	Gubbacka	Rakennus G2	NE	2002	VPS

Alanumero	Kohde	Aihe	Suunta	Vuosi	Kuvaaja
12	Gubbacka	Rakennus G3	SW	2002	VPS
13	Gubbacka	Rakennus G3	SW	2002	VPS
14	Gubbacka	Rakennus G3	NW	2002	VPS
15	Gubbacka	Rakennus G4	E	2002	VPS
16	Gubbacka	Rakennus G4	E	2002	VPS
17	Gubbacka	Rakennus G4	E	2002	VPS
18	Gubbacka	Rakennukset G3 ja G4	NW	2002	VPS
19	Gubbacka	Rakennukset G3 ja G4	NW	2002	VPS
20	Gubbacka	Rakennus G5	N	2002	VPS
21	Gubbacka	Rakennus G5	S	2002	VPS
22	Gubbacka	Rakennus G5	S	2002	VPS
23	Gubbacka	Rakennus G6	S	2002	VPS
24	Gubbacka	Rakennus G6	SE	2002	VPS
25	Gubbacka	Rakennus G7	E	2002	VPS
26	Gubbacka	Rakennus G7	E	2002	VPS
27	Gubbacka	Rakennus G7	E	2002	VPS
28	Gubbacka	Rakennus G7	SW	2002	VPS

Alanumero	Kohde	Aihe	Suunta	Vuosi	Kuvaaja
29	Gubbacka	Rakennus G7	SW	2002	VPS
30	Gubbacka	Rakennus G8	SW	2002	VPS
31	Gubbacka	Rakennus G8	S	2002	VPS
32	Gubbacka	Rakennus G8	S	2002	VPS
33	Gubbacka	Rakennus G8	S	2002	VPS
34	Gubbacka	Rakennus G9	S	2002	VPS
35	Gubbacka	Rakenukset G8 ja G9	SE	2002	VPS
36	Gubbacka	Rakenukset G8 ja G9	SE	2002	VPS
37	Gubbacka	Rakenukset G8 ja G9	S	2002	VPS
38	Gubbacka	Rakenukset G8 ja G9	S	2002	VPS
39	Gubbacka	Rakenukset G8 ja G9	N	2002	VPS
40	Gubbacka	Rakenukset G8 ja G9	N	2002	VPS
41	Gubbacka	Rakenukset G8 ja G9	N	2002	VPS
42	Gubbacka	Rakenukset G8 ja G9	N	2002	VPS
43	Gubbacka	Rakenukset G8 ja G9	NW	2002	VPS
44	Gubbacka	Rakennus G10	SE	2002	VPS
45	Gubbacka	Rakennus G10	SE	2002	VPS

Alanumero	Kohde	Aihe	Suunta	Vuosi	Kuvaaja
46	Gubbacka	Rakennus G10	SE	2002	VPS
47	Gubbacka	Rakennukset G11 ja G12	NE	2002	VPS
48	Gubbacka	Rakennus G11	E	2002	VPS
49	Gubbacka	Rakennus G11	S	2002	VPS
50	Gubbacka	Rakennus G12	N	2002	VPS
51	Gubbacka	Rakennus G13	N	2002	VPS
52	Gubbacka	Rakennus G13	N	2002	VPS
53	Gubbacka	Rakennus G14	S	2002	VPS
54	Gubbacka	Rakennus G15	SW	2002	VPS
55	Gubbacka	Rakennus G15	SE	2002	VPS
56	Gubbacka	Rakennus G16	SE	2002	VPS
57	Gubbacka	Rakennus G16	SE	2002	VPS
58	Gubbacka	Rakennus G16	NE	2002	VPS
59	Gubbacka	Rakennus G17	E	2002	VPS
60	Gubbacka	Koekuoppa 1, taso 1	NW	2002	VPS
61	Gubbacka	Koekuoppa 1, taso 1	SW	2002	VPS
62	Gubbacka	Koekuoppa 1, taso 1	NE	2002	VPS

Alanumero	Kohde	Aihe	Suunta	Vuosi	Kuvaaja
63	Gubbacka	Koekuoppa 1, taso 2	SW	2002	VPS
64	Gubbacka	Koekuoppa 1, taso 2	NE	2002	VPS
65	Gubbacka	Koekuoppa 1, taso 2	NW	2002	VPS
66	Gubbacka	Koekuoppa 1, pohja	NE	2002	VPS
67	Gubbacka	Koekuoppa 1, pohja	NE	2002	VPS
68	Gubbacka	Koekuoppa 2, taso 1	SE	2002	VPS
69	Gubbacka	Koekuoppa 2, taso 1	NW	2002	VPS
70	Gubbacka	Koekuoppa 2, taso 1	E	2002	VPS
71	Gubbacka	Koekuoppa 2, taso 1	NW	2002	VPS
72	Gubbacka	Koekuoppa 2, taso 1	NE	2002	VPS
73	Gubbacka	Koekuoppa 2, taso 1	W	2002	VPS
74	Gubbacka	Koekuoppa 2, taso 1	NE	2002	VPS
75	Gubbacka	Koekuoppa 2, taso 1	NE	2002	VPS
76	Gubbacka	Koekuoppa 2, leikkaus	E	2002	VPS
77	Gubbacka	Koekuoppa 2, leikkaus	W	2002	VPS
78	Gubbacka	Koekuoppa 2, leikkaus	E	2002	VPS
79	Gubbacka	Koekuoppa 2, leikkaus	NW	2002	VPS

Alanumero	Kohde	Aihe	Suunta	Vuosi	Kuvaaja
80	Gubbacka	Koekuoppa 2, leikkaus	NE	2002	VPS
81	Gubbacka	Koekuoppa 2, leikkaus	NE	2002	VPS
82	Gubbacka	Koekuoppa 2, leikkaus	NE	2002	VPS
83	Gubbacka	Koekuoppa 2, leikkaus	NE	2002	VPS
84	Gubbacka	Koekuoppa 2, leikkaus	NW	2002	VPS
85	Gubbacka	Koekuoppa 2, leikkaus	S	2002	VPS
86	Gubbacka	Koekuoppa 3, taso 1	NE	2002	VPS
87	Gubbacka	Koekuoppa 3, taso 1	W	2002	VPS
88	Gubbacka	Koekuoppa 3, taso 1	SE	2002	VPS
89	Gubbacka	Koekuoppa 3, taso 1	W	2002	VPS
90	Gubbacka	Koekuoppa 3, taso 2	NE	2002	VPS
91	Gubbacka	Koekuoppa 3, taso 2	NW	2002	VPS
92	Gubbacka	Koekuoppa 3, taso 2	S	2002	VPS
93	Gubbacka	Koekuoppa 3, taso 2	E	2002	VPS
94	Gubbacka	Koekuoppa 3, pohja	E	2002	VPS
95	Gubbacka	Koekuoppa 3, pohja	S	2002	VPS
96	Gubbacka	Koekuoppa 3, pohja	S	2002	VPS

Alanumero	Kohde	Aihe	Suunta	Vuosi	Kuvaaja
97	Gubbacka	Koekuoppa 3, pohja	E	2002	VPS
98	Gubbacka	Koekuoppa 3, pohja	NE	2002	VPS
99	Gubbacka	Labbenin tontti	N	2002	VPS
100	Gubbacka	Labbenin tontti	N	2002	VPS
101	Gubbacka	Rakennus L1	W	2002	VPS
102	Gubbacka	Rakennus L1	W	2002	VPS
103	Gubbacka	Rakennus L2	N	2002	VPS
104	Gubbacka	Rakennus L2	NW	2002	VPS
105	Gubbacka	Rakennus L3	NW	2002	VPS
106	Gubbacka	Rakennus L4	SE	2002	VPS
107	Gubbacka	Rakennus L5	SE	2002	VPS
108	Gubbacka	Rakennus L 6	E	2002	VPS
109	Gubbacka	Rakennus L 6	E	2002	VPS
110	Gubbacka	Rakennus L7	E	2002	VPS
111	Gubbacka	Rakennus L8	E	2002	VPS
112	Gubbacka	Rakennus L9	E	2002	VPS
113	Gubbacka	Rakennus L10	N	2002	VPS

Alanumero	Kohde	Aihe	Suunta	Vuosi	Kuvaaja
114	Gubbacka	Rakennus L11	N	2002	VPS
115	Gubbacka	Rakennus L12	NW	2002	VPS
116	Gubbacka	Labben, koekuoppa turpeen poiston jälkeen.	S	2002	VPS
117	Gubbacka	Labben, koekuoppa turpeen poiston jälkeen.	NE	2002	VPS
118	Gubbacka	Labben, koekuoppa, uunirakenne esiin otettuna	W	2002	VPS
119	Gubbacka	Labben, koekuoppa, uunirakenne esiin otettuna	NE	2002	VPS
120	Gubbacka	Labben, koekuoppa, Tiilirakenne esille otettuna	S	2002	VPS
121	Gubbacka	Labben, koekuoppa, Tiilirakenne esille otettuna	NE	2002	VPS
122	Gubbacka	Labben, koekuoppa, uunin edustan puurakenne	NE	2002	VPS
123	Gubbacka	Labben, koekuoppa, pohja	NE	2002	VPS
124	Gubbacka	Labben, koekuoppa, pohja	NE	2002	VPS
125	Gubbacka	Labben, koekuoppa, pohja	NW	2002	VPS
126	Gubbacka	Labben, koekuoppa, pohja	W	2002	VPS
127	Gubbacka	Labben, koekuoppa, pohja	NW	2002	VPS
128	Gubbacka	Labben, koekuoppa, pohja	SE	2002	VPS

LIITE 7

Länsisalmi Gubbacka

Mustavalkokuvat 2002

MV/RHO 125 243

Alanumero	Kohde	Aihe	Suunta	Kuvaaja
1	Gubbacka	Peltoa Gubbackan tontin edustalla	W	VPS
2	Gubbacka	Rakennus G1	S	VPS
3	Gubbacka	Rakennus G1	SE	VPS
4	Gubbacka	Rakennus G2	E	VPS
5	Gubbacka	Rakennus G2	E	VPS
6	Gubbacka	Rakennus G3	N	VPS
7	Gubbacka	Rakennus G3	N	VPS
8	Gubbacka	Rakennus G4	E	VPS
9	Gubbacka	Rakennus G4	E	VPS
10	Gubbacka	Rakennus G5	N	VPS
11	Gubbacka	Rakennus G5	S	VPS
12	Gubbacka	Rakennus G6	S	VPS
13	Gubbacka	Rakennus G7	SE	VPS
14	Gubbacka	Rakennus G7	SW	VPS
15	Gubbacka	Rakennus G8	W	VPS
16	Gubbacka	Rakennus G8	S	VPS

Alanumero	Kohde	Aihe	Suunta	Kuvaaja
17	Gubbacka	Rakennus G8	S	VPS
18	Gubbacka	Rakennus G9	S	VPS
19	Gubbacka	Rakennus G9	S	VPS
20	Gubbacka	Rakennukset G8 & G9	S	VPS
21	Gubbacka	Rakennukset G8 & G9	N	VPS
22	Gubbacka	Rakennukset G8 & G9	N	VPS
23	Gubbacka	Rakennukset G8 & G9	N	VPS
24	Gubbacka	Rakennus G10	S	VPS
25	Gubbacka	Rakennus G10	S	VPS
26	Gubbacka	Koekuoppa 1, taso 1	NW	VPS
27	Gubbacka	Koekuoppa 1, taso 1	S	VPS
28	Gubbacka	Koekuoppa 1, taso 1	S	VPS
29	Gubbacka	Koekuoppa 1, taso 1	NE	VPS
30	Gubbacka	Kylätontti pellolta päin	S	VPS
31	Gubbacka	Kylätontti pellolta päin	S	VPS
32	Gubbacka	Rakennus G11	E	VPS
33	Gubbacka	Rakennus G11	E	VPS
34	Gubbacka	Rakennus G11	S	VPS
35	Gubbacka	Rakennus G12	E	VPS
36	Gubbacka	Rakennus G11	SW	VPS
37	Gubbacka	Rakennus G11	SW	VPS
38	Gubbacka	Rakennus G12	N	VPS

Alanumero	Kohde	Aihe	Suunta	Kuvaaja
39	Gubbacka	Rakennus G13	N	VPS
40	Gubbacka	Koekuoppa 1, taso 2	SW	VPS
41	Gubbacka	Koekuoppa 1, taso 2	NE	VPS
42	Gubbacka	Koekuoppa 1, taso 2	E	VPS
43	Gubbacka	Rakennus G14	SE	VPS
44	Gubbacka	Koekuoppa 1, pohja	SW	VPS
45	Gubbacka	Koekuoppa 1, pohja	NE	VPS
46	Gubbacka	Koekuoppa 1, pohja	E	VPS
47	Gubbacka	Koekuoppa 2 ennen kaivausta	E	VPS
48	Gubbacka	Koekuoppa 3:n paikka	N	VPS
49	Gubbacka	Rakennus G15	W	VPS
50	Gubbacka	Rakennus G15	W	VPS
51	Gubbacka	Rakennus G15	W	VPS
52	Gubbacka	Rakennus G17	E	VPS
53	Gubbacka	Koekuoppa 2, taso 1	SE	VPS
54	Gubbacka	Koekuoppa 2, taso 1	SE	VPS
55	Gubbacka	Koekuoppa 2, taso 1	SW	VPS
56	Gubbacka	Koekuoppa 2, taso 1	NW	VPS
57	Gubbacka	Koekuoppa 3, taso 1	NE	VPS
58	Gubbacka	Koekuoppa 3, taso 1	SE	VPS
59	Gubbacka	Koekuoppa 3, taso 1	S	VPS
60	Gubbacka	Koekuoppa 3, taso 1	W	VPS

Alanumero	Kohde	Aihe	Suunta	Kuvaaja
61	Gubbacka	Koekuoppa 3, taso 2	SE	VPS
62	Gubbacka	Koekuoppa 3, taso 2	S	VPS
63	Gubbacka	Koekuoppa 3, taso 2	N	VPS
64	Gubbacka	Koekuoppa 3, taso 2	NE	VPS
65	Gubbacka	Rakennus G16	SE	VPS
66	Gubbacka	Rakennus G16	SE	VPS
67	Gubbacka	Rakennus G16	E	VPS
68	Gubbacka	Koekuoppa 3, pohja.	NE	VPS
69	Gubbacka	Koekuoppa 3, pohja.	SW	VPS
70	Gubbacka	Koekuoppa 3, pohja.	SE	VPS
71	Gubbacka	Koekuoppa 3, pohja.	E	VPS
72	Gubbacka	Koekuoppa 2, leikkaus	S	VPS
73	Gubbacka	Koekuoppa 2, leikkaus	S	VPS
74	Gubbacka	Koekuoppa 2, leikkaus	E	VPS
75	Gubbacka	Koekuoppa 2, leikkaus	E	VPS
76	Gubbacka	Koekuoppa 2, leikkaus	NE	VPS
77	Gubbacka	Koekuoppa 2, leikkaus	NW	VPS
78	Gubbacka	Rakennus L1	W	VPS
79	Gubbacka	Rakennus L1	W	VPS
80	Gubbacka	Rakennus L2	SW	VPS
81	Gubbacka	Rakennus L 3	SE	VPS
82	Gubbacka	Labben, koekuoppa turpeen poiston jälkeen	NE	VPS

Alanumero	Kohde	Aihe	Suunta	Kuvaaja
83	Gubbacka	Labben, koekuoppa turpeen poiston jälkeen	S	VPS
84	Gubbacka	Rakennus L4	NE	VPS
85	Gubbacka	Rakennus L5	NE	VPS
86	Gubbacka	Rakennus L6	E	VPS
87	Gubbacka	Rakennus L6	E	VPS
88	Gubbacka	Rakennus L7	E	VPS
89	Gubbacka	Rakennus L8	E	VPS
90	Gubbacka	Rakennus L9	E	VPS
91	Gubbacka	Rakennus L9	N	VPS
92	Gubbacka	Rakennus L10	N	VPS
93	Gubbacka	Rakennus L11	E	VPS
94	Gubbacka	Labben	NE	VPS
95	Gubbacka	Labben	NE	VPS
96	Gubbacka	Labben	NE	VPS
97	Gubbacka	Labben	NE	VPS
98	Gubbacka	Labben	NE	VPS
99	Gubbacka	Labben	NE	VPS
100	Gubbacka	Labben	NE	VPS
101	Gubbacka	Labben, koekuoppa. Uunin seinä esiin otettuna	N	VPS
102	Gubbacka	Labben, koekuoppa. Uunin seinä esiin otettuna	N	VPS
103	Gubbacka	Labben, koekuoppa. Uunin seinä esiin otettuna	NW	VPS
104	Gubbacka	rakennus L12	NW	VPS

Alanumero	Kohde	Aihe	Suunta	Kuvaaja
105	Gubbacka	Labben koekuoppa, tiilirakenne on otettu esiin	NW	VPS
106	Gubbacka	Labben koekuoppa, tiilirakenne on otettu esiin	NE	VPS
107	Gubbacka	Labben koekuoppa, uunin edustan kiviä poistettu enemmän	S	VPS
108	Gubbacka	Labben koekuoppa, uunin edustan kiviä poistettu enemmän	NW	VPS
109	Gubbacka	Labben, koekuoppa, uunin edustan puurakenne	N	VPS
110	Gubbacka	Labben, koekuoppa, uunin edustan puurakenne	N	VPS
111	Gubbacka	Labben, koekuoppa, uunin edustan puurakenne	NE	VPS
112	Gubbacka	Labben, koekuoppa, pohja	S	VPS
113	Gubbacka	Labben, koekuoppa, pohja	NW	VPS
114	Gubbacka	Labben, koekuoppa, pohja	NW	VPS
115	Gubbacka	Labben, koekuoppa, pohja	S	VPS
116	Gubbacka	Labben, koekuoppa, pohja	N	VPS
117	Gubbacka	Labben, koekuoppa, pohja	S	VPS
118	Gubbacka	Labben, koekuoppa, pohja	S	VPS

LIITE 8

Vantaa Länsisalmi Gubbacka

Löydöt 2002

KM 2002090

Alanumero	Koekuoppa	Taso	Materiaali	Laji	Kpl	Paino	Mitat
1	KK I		Punasavi	Astia	1	3,5 g	1,9 x 1,8 x 0,7
2	KK I		Punasavi	Astia	1	7,1 g	4,7 x 3,1 x 0,6
3	KK II	Pinta	Savi	Tiiviste	4	14,0 g	
4	KK II	Turpeenalainen likamaa	Rauta	Naula	1	6,6 g	3,8 x 1,6 x 0,8
5	KK II	Turpeenalainen likamaa	Rauta	Esine	1	4,8 g	1,5 x 0,8 x 0,6
6	KK II	Turpeenalainen likamaa	Savi	Tiili	13	21,5 g	
7	KK II	Turpeenalainen likamaa	Savi	Muototiili	1	298,4 g	8,6 x 8,0 x 3,7
8	KK II	Turpeenalainen likamaa	Savi	Tiili	6	153,7 g	
9	KK II	Turpeenalainen likamaa	Kivi	Pii	1	0,4 g	1,4 x 1,0 x 0,3
10	KK II	Turpeenalainen likamaa	Savi	Tiiviste	181	525,3 g	Suurimmat n.
11	KK II	Turpeenalainen likamaa	Luu		2	0,3 g ja 0,2 g	2,7 x 0,6 x 0,2
12	KK II	Turpeenalainen likamaa	Laasti		7	6,7 g	Suurin 2,5 x 2,
13	KK II	Tiivis harmaa likamaa	Savi	Tiili	1	16,3 g	4,1 x 3,4 x 1,6
14	KK II	Tiivis harmaa likamaa	Kivi		1	81,4 g	5,7 x 4,4 x 1,7

Alanumero	Koekuoppa	Taso	Materiaali	Laji	Kpl	Paino	Mitat
15	KK II	Tiivis harmaa likamaa	Savi	tiiviste	107	655,1 g	Suurimmat n.
16	KK II	Tiivis harmaa likamaa	Luu		8	88,2 g	Suurin 14,9 x 6
17	KK III	Pinta	Luu		1	0,2 g	0,8 x 0,6 x 0,4
18	KK III	Pinnan alainen likamaa.	Rauta	Naula	1	5,8 g	4,3 x 1,6 x 1,0
19	KK III	Pinnan alainen likamaa.	Rauta	Veitsi?	1	8,5 g	4,6 x 1,6 x 0,6
20	KK III	Pinnan alainen likamaa.	Meripihka		1	0,2 g	0,8 x 0,8 x 0,4
21	KK III	Pinnan alainen likamaa.	Hiili		1	0,1 g	1,0 x 0,7 x 0,6

Taso 1

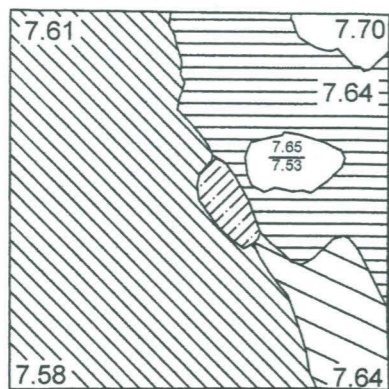

563540.37
682055.24

Pohja

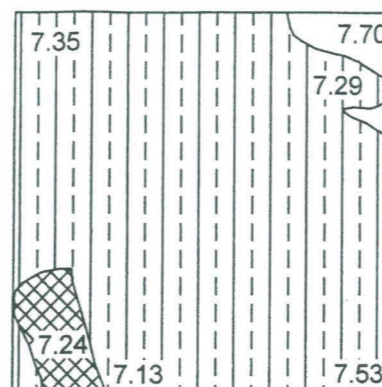

563540.37
682055.24



Neulapohjoinen

Taso 2

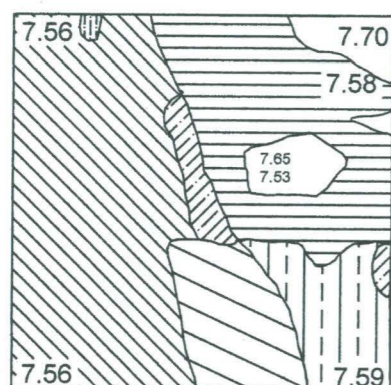

563540.37
682055.24

Profiili pohjoisesta

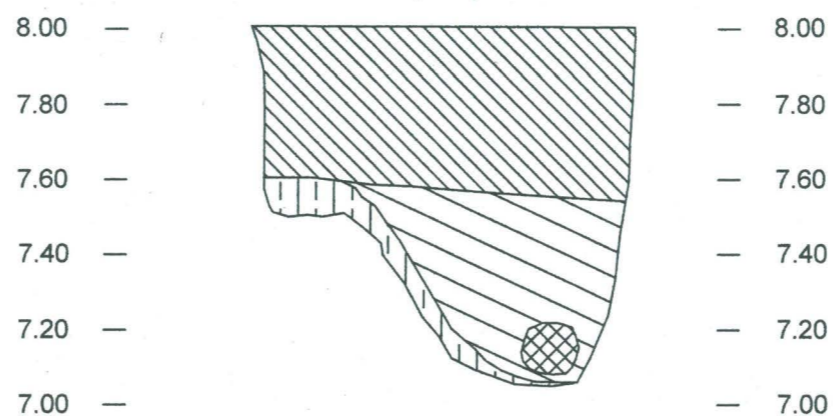

-  Sav.sekainen vaaleanharmaa hiekka
-  Sav.sekainen ruskea hiekka
-  Sav.sekainen vaaleanruskea hiekka
-  Vaalea savi
-  Savi
-  Multakerros
-  Kivi
-  Salaoja



VANTAA Länsisalmi, Gubbacka V.-P. Suhonen	Koekuoppa 1 Tasokartat 1 - pohja ja profiili pohjoisesta Korkeudet m m.p.y. mk 1:20	
	MUSEOVIRASTO RAKENNUSHISTORIAN OSASTO	
MITTAPIIRRUSTUS A. Koivisto	KULTTUURITALO PL 169 00511	puht.piirt. D. Lillqvist



Neulapohjoinen

Taso 1

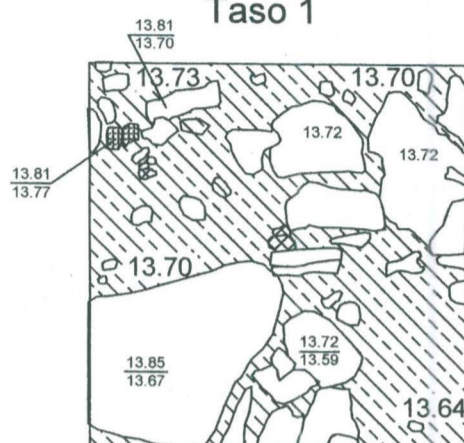

563528.90
682084.58

Taso 2

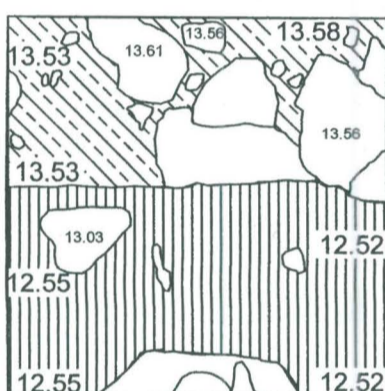

563528.90
682084.58



Puhdas hiekka



Tiivis harmaa humus



Kivi



Palanut savi



Tiili



1 m

VANTAA Länsisalmi, Gubbacka V.-P. Suhonen	Koekuoppa 2 Tasot 1 ja 2 Korkeudet m m.p.y. mk 1:20	
	MUSEOVIRASTO RAKENNUSHISTORIAN OSASTO	
MITTAPIIRRUSTUS	KULTTUURITALO PL 169 00511	puht.piirt. D. Lilqvist







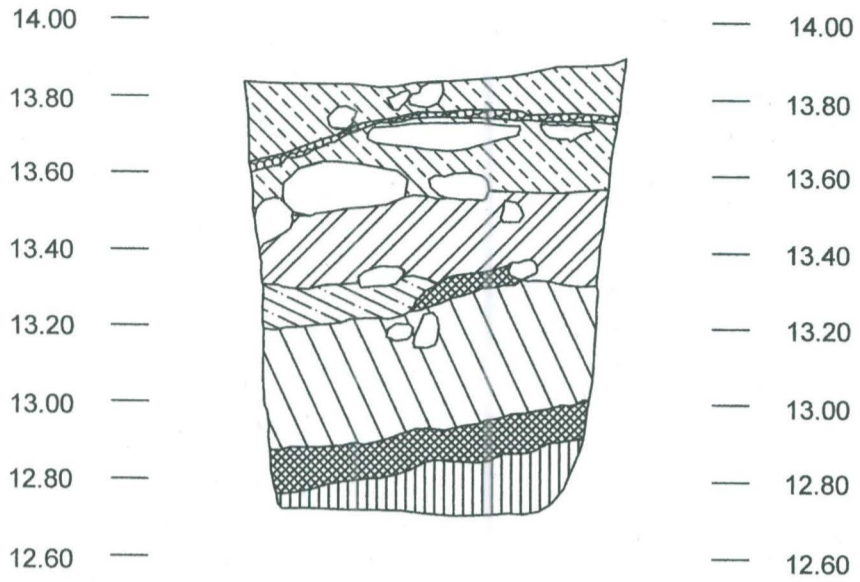

Neulapohjoinen

Profiili pohjoisesta



Profiili etelästä

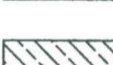
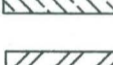
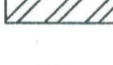

-  Rautapitoinen kova hiekka
-  Likainen hiekka
-  Vaalea hiekka
-  Puhdas hiekka
-  Tiivis harmaa humus
-  Hiekka täytemaa
-  Kivi
-  Juuri

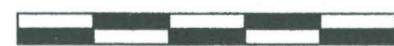

1 m

VANTAA Länsisalmi, Gubbacka	Koekuoppa 2	
	Etelä- ja pohjoisprofiili Korkeudet m m.p.y. mk 1:20	
MUSEOVIRASTO RAKENNUSHISTORIAN OSASTO		
MITTAPIIRRUSTUS A. Koivisto	KULTTUURITALO PL 169 00511	puht.piirt. D. Lillqvist

Taso 1

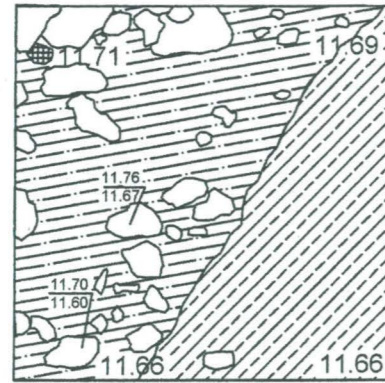

563535.92
682079.76

Taso 3

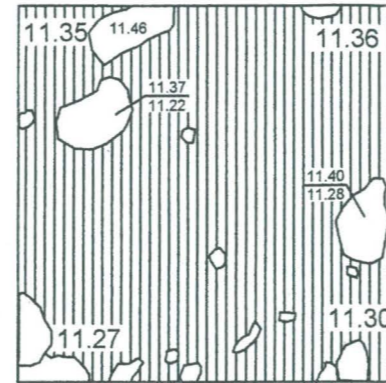

563535.92
682079.76

Taso 2

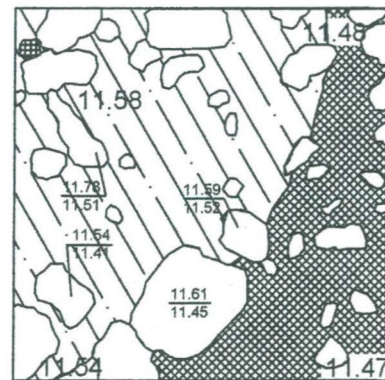

563535.92
682079.76

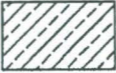
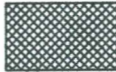

-  Rautapitoinen savensekainen hiekka
-  Vaalea savipitoinen hiekka
-  Vaaleanruskea savi- ja rautapitoinen hiekka
-  Rautapitoinen kova hiekka
-  Puhdas hiekka
-  Kivi
-  Tiili



VANTAA		Koekuoppa 3	
Länsisalmi, Gubbacka		Tasot 1 - 3	
V.-P. Suhonen 2002		Korkeudet m m.p.y. mk 1:20	
MUSEOVIRASTO RAKENNUSHISTORIAN OSASTO			
MITTAPIIRRUSTUS	KULTTUURITALO	puht.piirt.	
R. Mäki	PL 169	D. Lillqvist	
	00511		



Neulapohjoinen

Profiili idästä

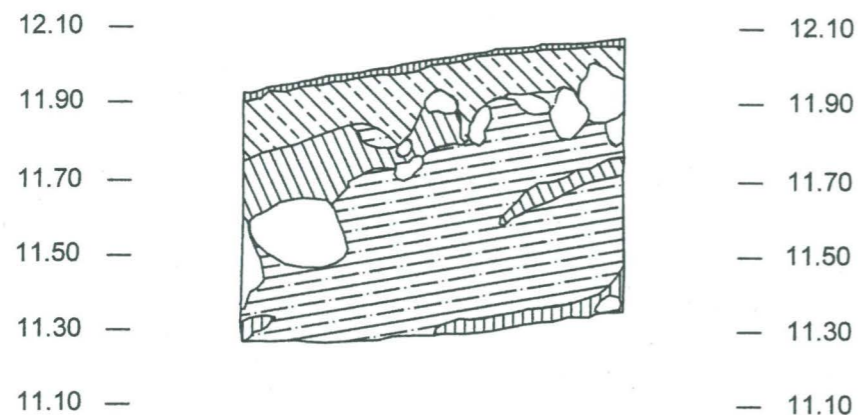

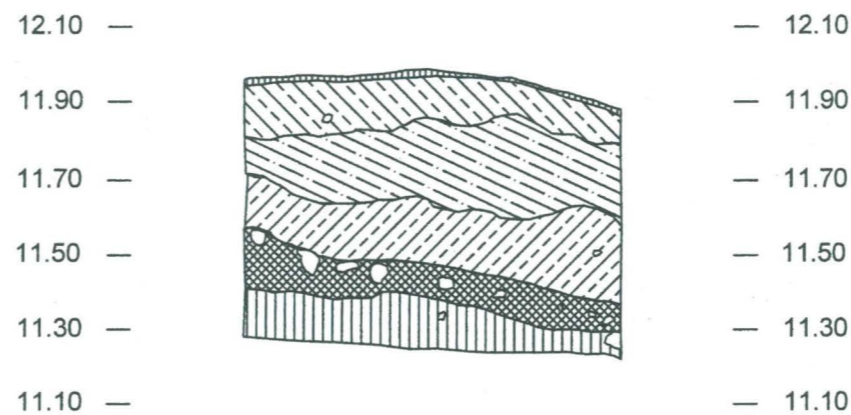

Profiili lännestä

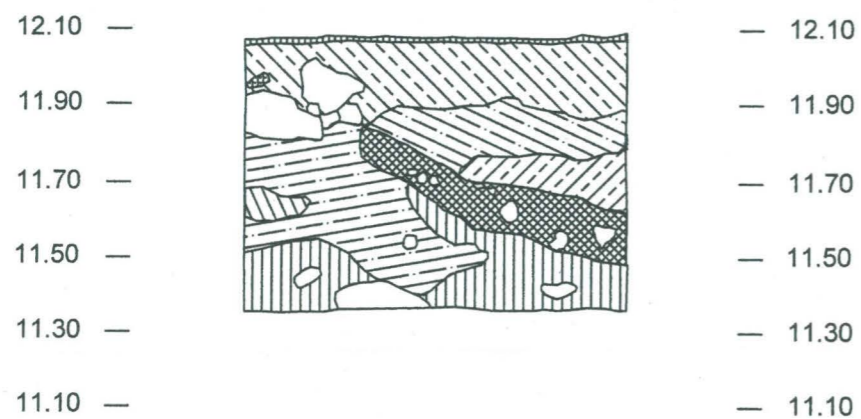

Profiili etelästä



-  Turvekerros
-  Tiivis harmaa humus
-  Vaalea savensekainen hiekka
-  Rautapitoinen savensekainen hiekka
-  Vaalea savipitoinen täytemaa
-  Rautapitoinen kova hiekka
-  Puhdas hiekka
-  Kivi
-  Tiili



VANTAA		Koekuoppa 3	
Länsisalmi, Gubbacka V.-P. Suhonen 2002		Profiilit idästä, lännestä ja etelästä Korkeudet m m.p.y. mk 1:20	
MUSEOVIRASTO RAKENNUSHISTORIAN OSASTO			
MITTAPIIRRUSTUS	KULTTUURITALO PL 169 00511	puht.piirt. D. Lillqvist	



Neulapohjoinen

Uunin kulma

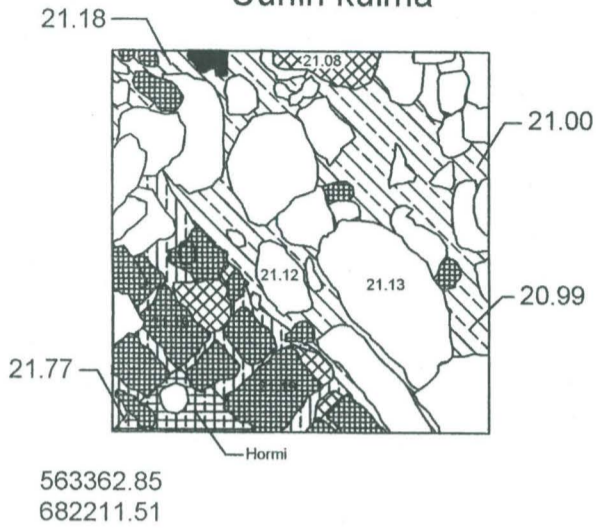

Profiili pohjoisesta

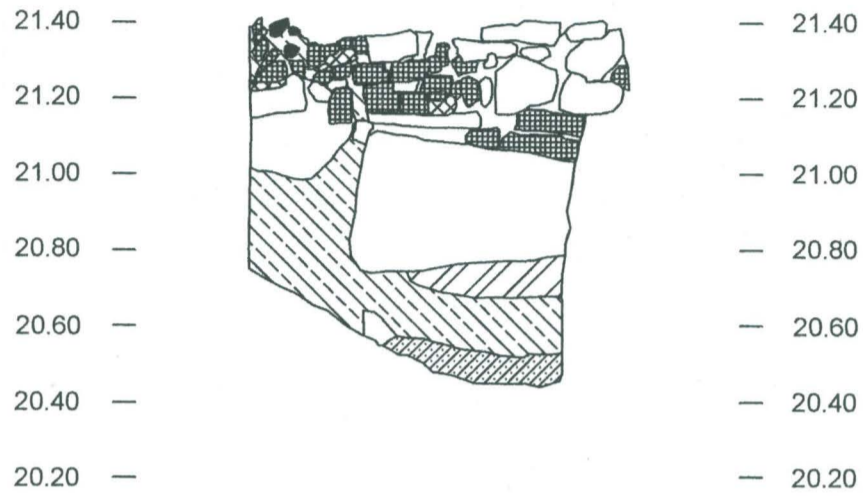

Puurakenne

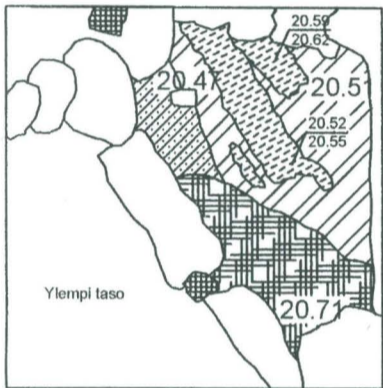

Profiili idästä

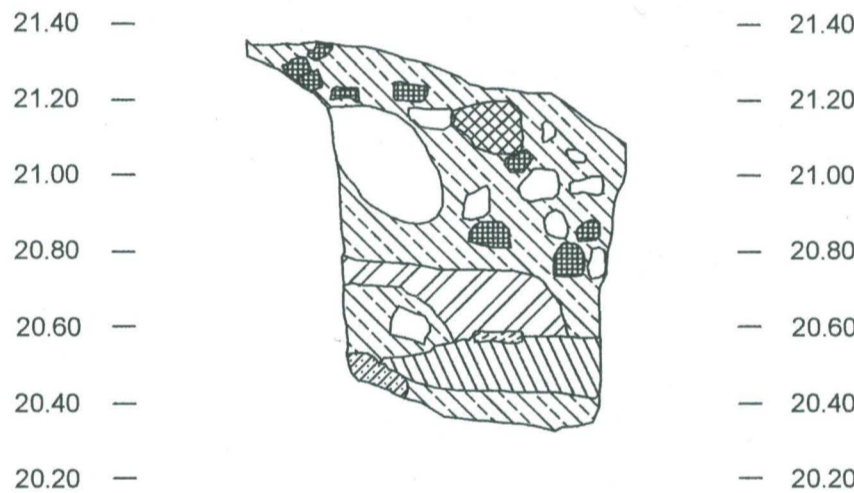

Pohja

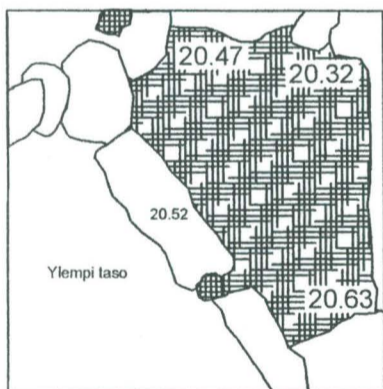

-  Tiivis harmaa humus
-  Laastinsekainen hiekka
-  Kova hiilensekainen hiekka
-  Vaalea hiekka, täytemaa
-  Peruskallio
-  Vaalea savensekainen hiekka
-  Kivi
-  Palanut savi
-  Tiili
-  Laasti



VANTAA Länsisalmi, Labben V:-P-Suhonen 2002	Koekuoppa 1 Tasokartat uunin kulma, puurakenteet ja pohja Profiilit pohjoisesta ja idästä Korkeudet m.m.p.y. mk 1:20	
	MUSEOVIRASTO RAKENNUSHISTORIAN OSASTO	
MITTAPIIRRUSTUS A. Koivisto	KULTTUURITALO PL 169 00511	puht.piiirt. D. Lillqvist

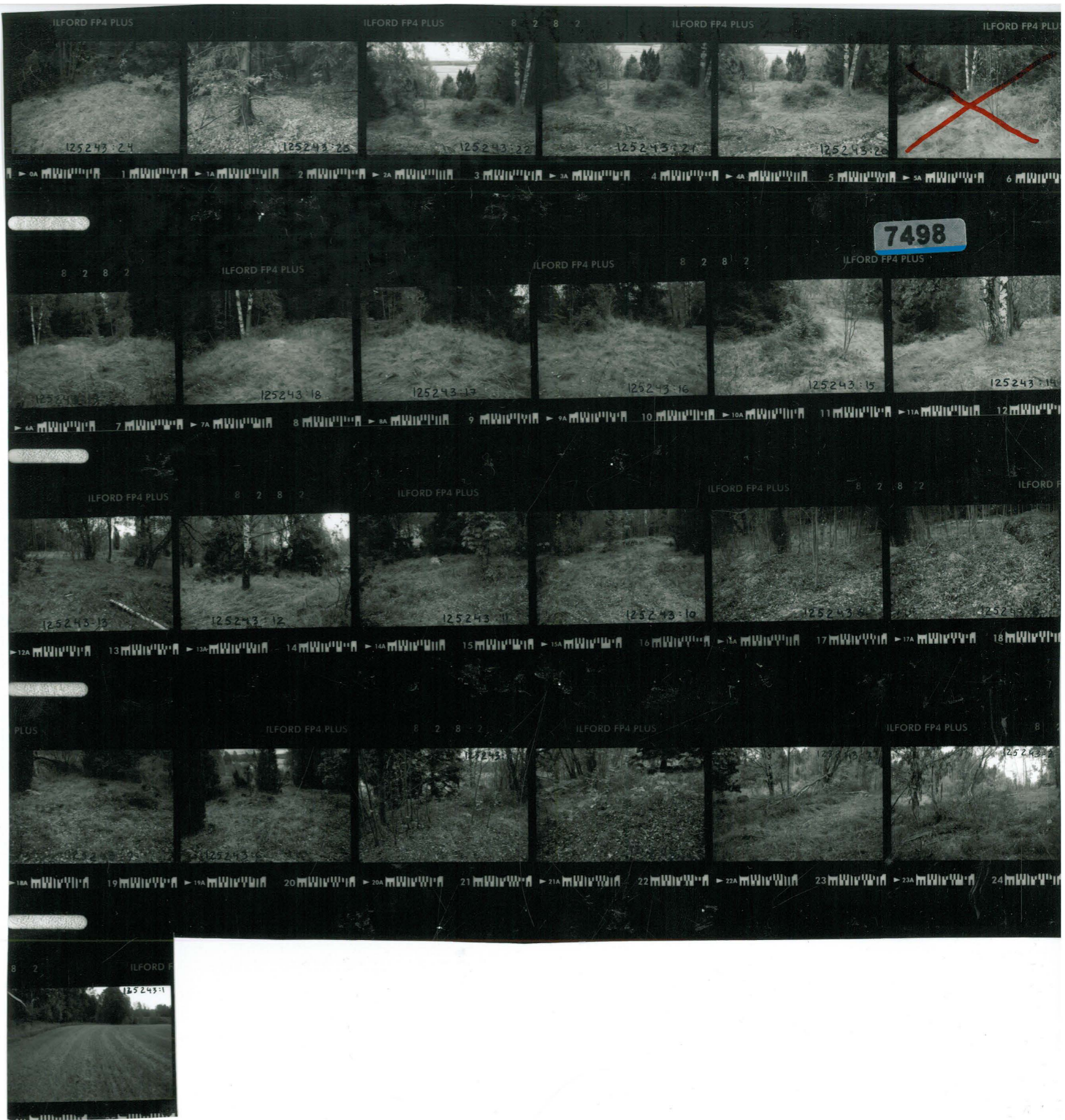

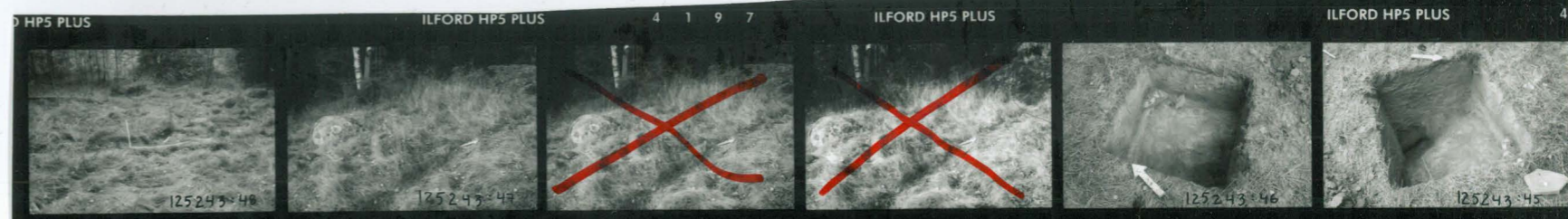

7496

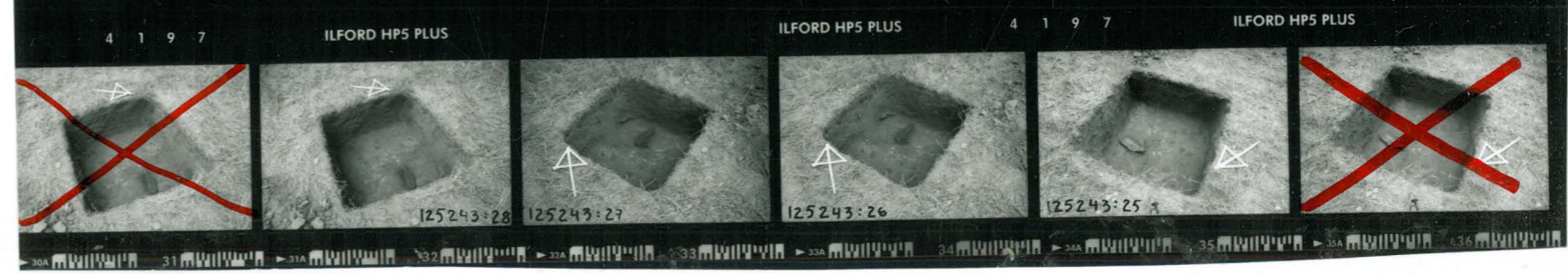
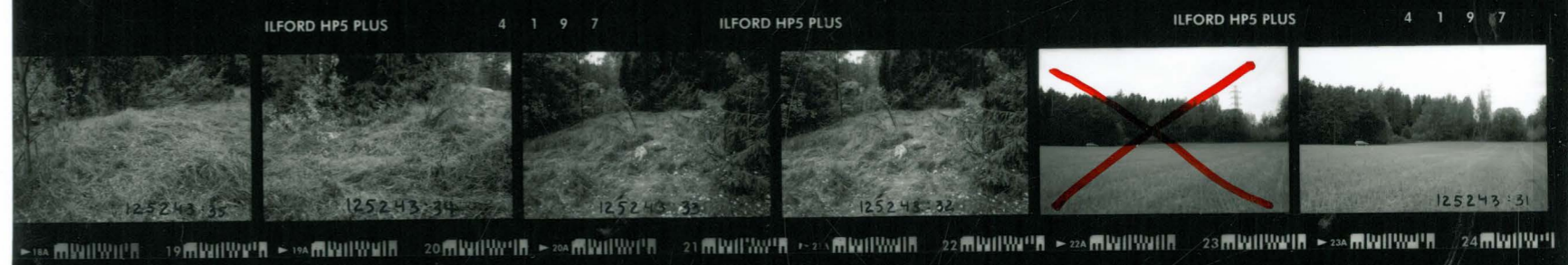
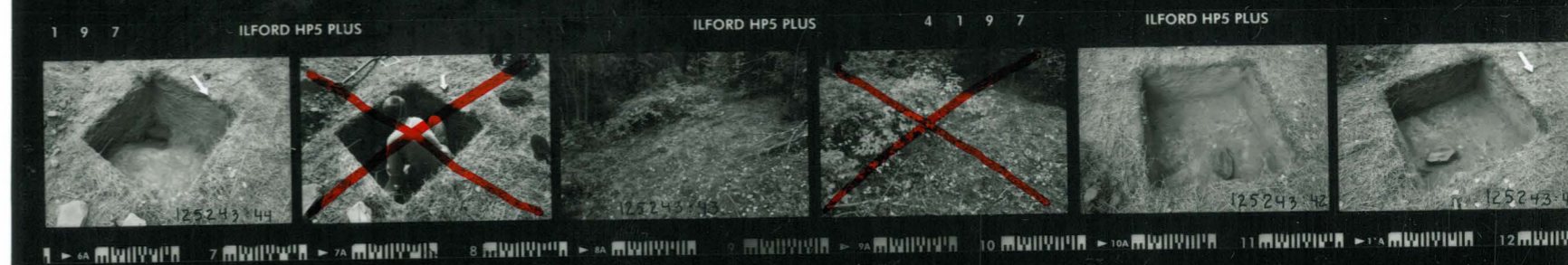





7495

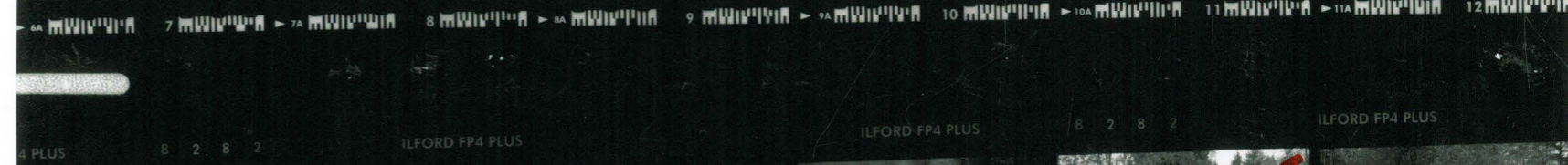
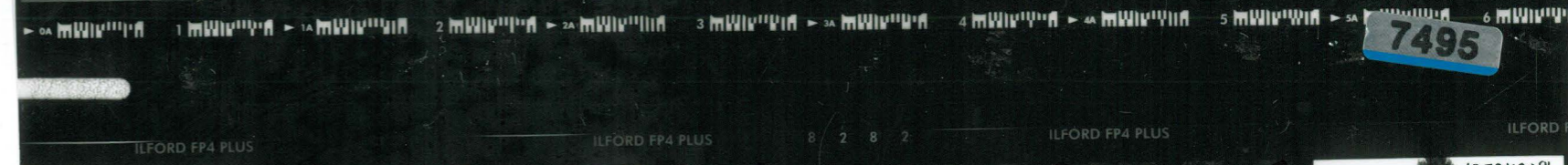

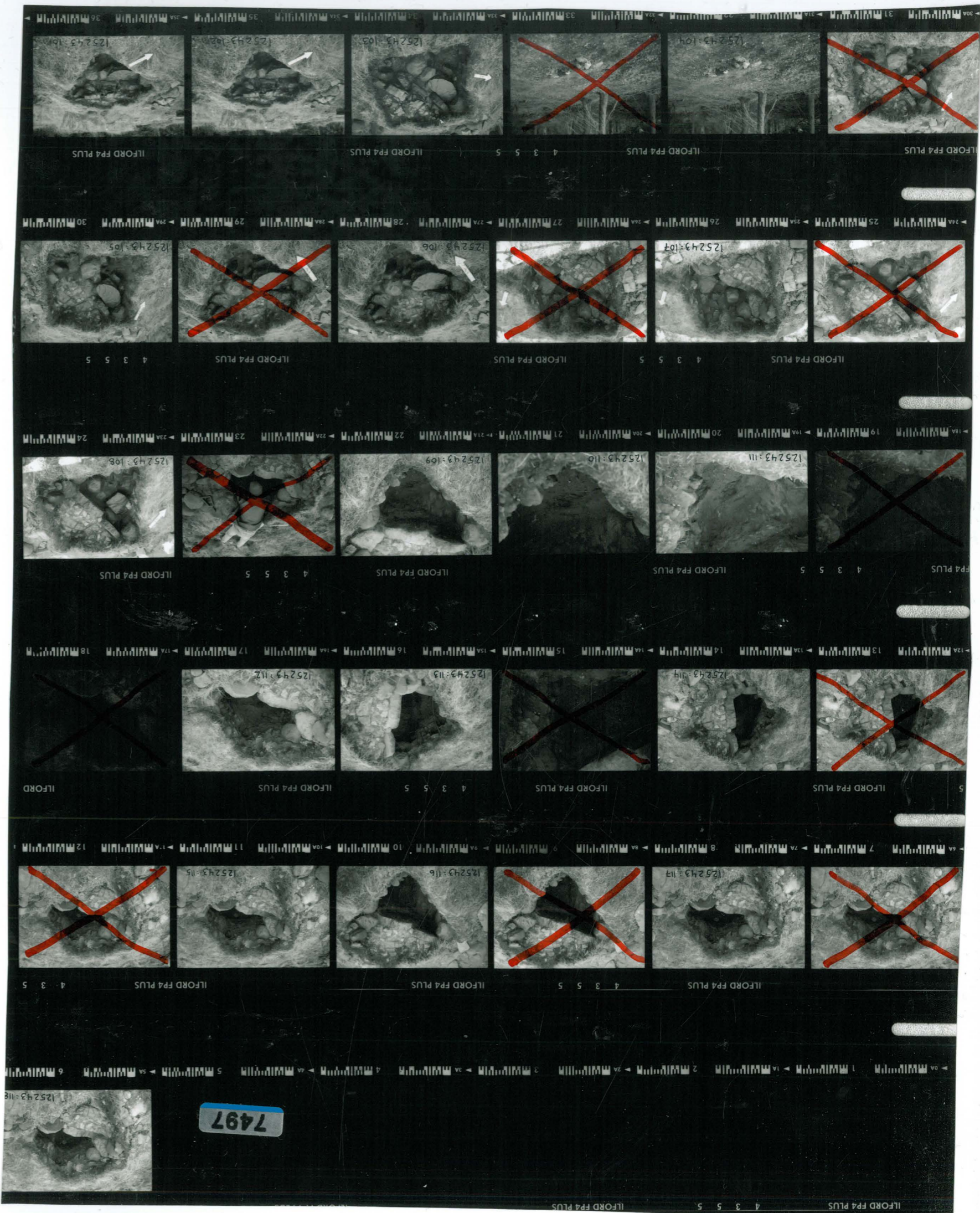

7497

ILFORD FP4 PLUS

ILFORD FP4 PLUS

ILFORD FP4 PLUS

ILFORD FP4 PLUS

ILFORD FP4 PLUS

ILFORD FP4 PLUS

ILFORD FP4 PLUS

ILFORD FP4 PLUS

ILFORD FP4 PLUS

ILFORD FP4 PLUS

ILFORD FP4 PLUS

ILFORD FP4 PLUS

ILFORD

ILFORD FP4 PLUS

ILFORD FP4 PLUS

ILFORD FP4 PLUS

ILFORD FP4 PLUS

ILFORD FP4 PLUS

ILFORD FP4 PLUS

ILFORD FP4 PLUS

ILFORD FP4 PLUS

ILFORD FP4 PLUS

ILFORD FP4 PLUS

125243-104

125243-105

125243-106

125243-107

125243-105

125243-106

125243-107

125243-108

125243-109

125243-110

125243-111

125243-112

125243-113

125243-114

125243-115

125243-116

125243-117

125243-118