

# SOTKAMO RÄÄTÄKANGAS

PERUSKARTTA 4411 04

ESA SUOMINEN 1999

YLEISKARTTA

MK 1:500

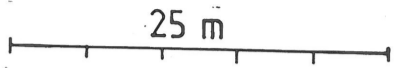

PIIRT. A. VIKKULA 1985

L. MANNINEN 1999

TUTKITTU ALUE V. 1985

TUTKITTU ALUE V. 1999

- MÄNTYMETSÄ
- NUORI MÄNTYMETSÄ
- HAKKUUALUE
- RANTAHEINIKKO
- KIINTOPISTE
- RANTATÖYRÄS

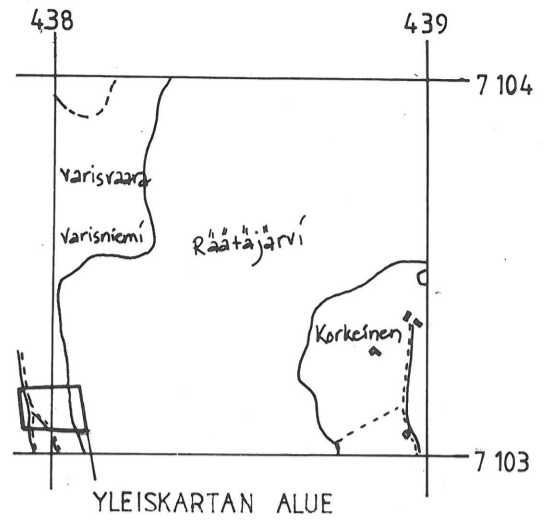

YLEISKARTAN ALUE

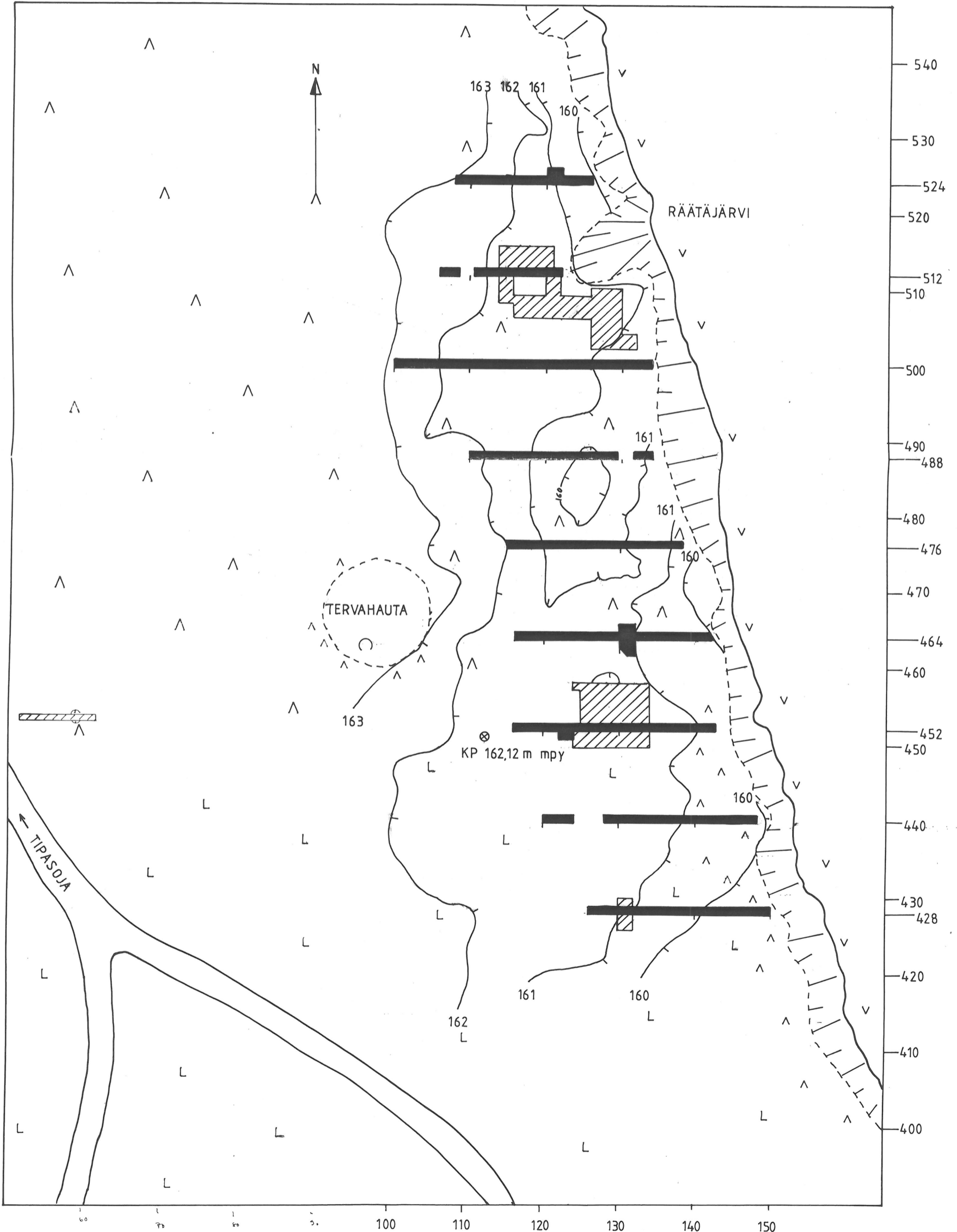

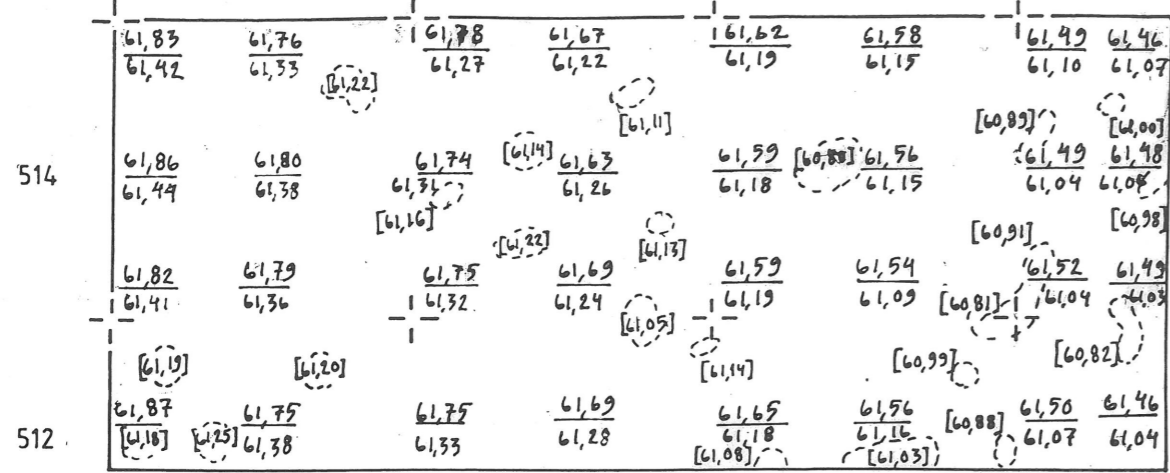

# SOTKAMO RÄÄTÄKANGAS

ESA SUOMINEN 1999

RUUDUT 502/126-130, 504/126-128, 506/116-128, 508/114-130,  
510/114,120, 512/114-120, 514/114-120

PINTA- JA POHJALUVUT

MK 1:50  1 m

KP 204 = 162.12 m mpy

PIIRT. L. MANNINEN

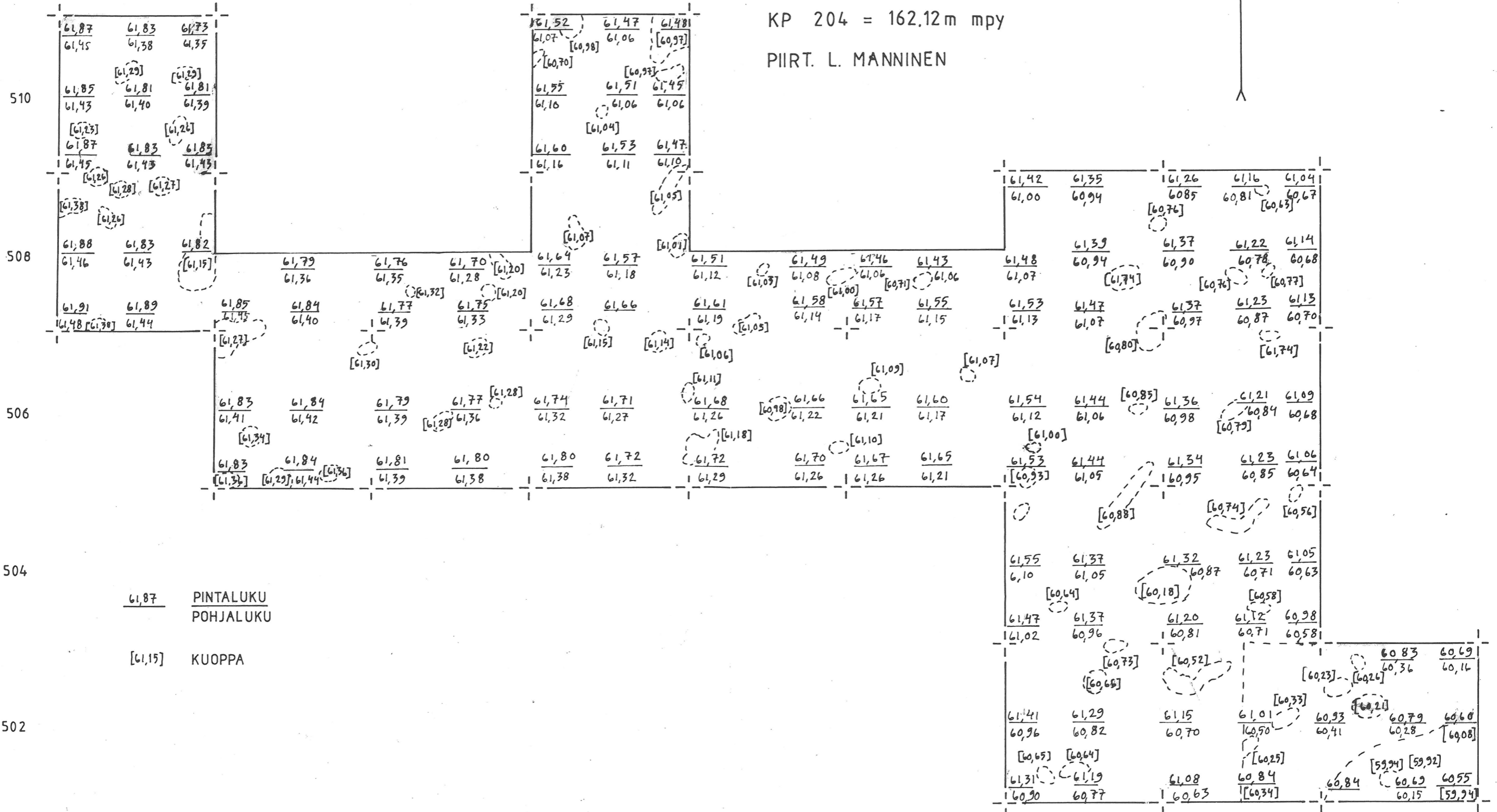

# SOTKAMO RÄÄTÄKANGAS

ESA SUOMINEN 1999

RUUDUT 502/126-130, 504/126-128, 506/116-128, 508/114-130,  
510/114, 120, 512/114-120, 514/114-120





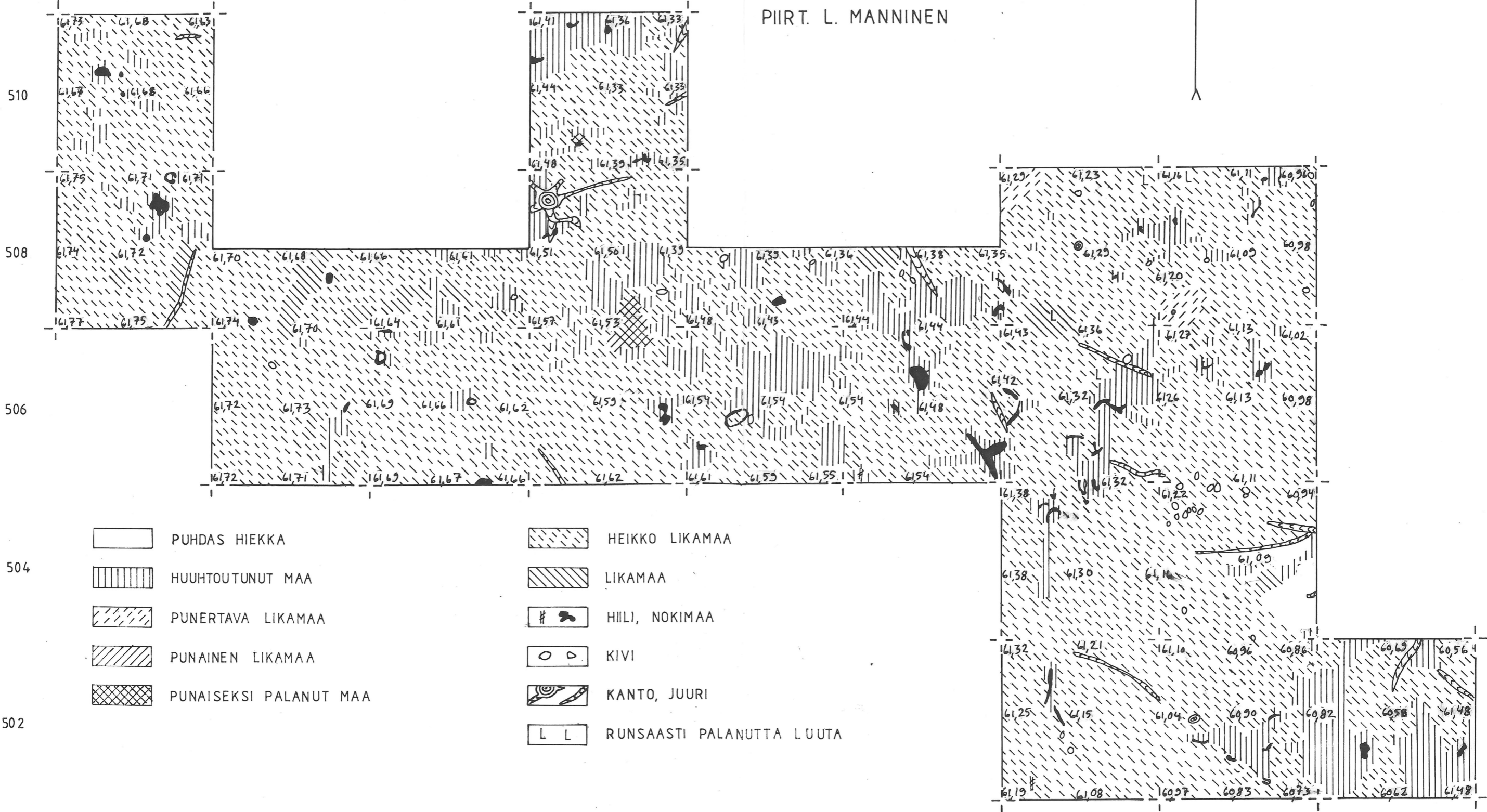
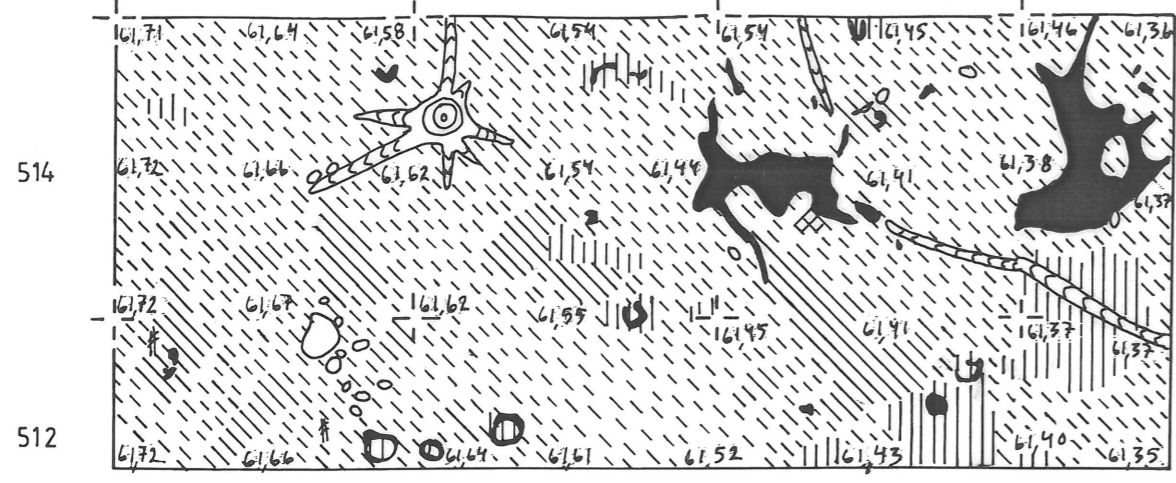

TASO 1

MK 1:50 

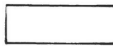
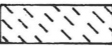
KP 204 = 162.12 m mpy

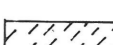
PIIRT. L. MANNINEN

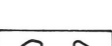
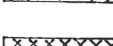
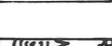

- |   |                        |   |                           |
|---|------------------------|---|---------------------------|
|  | PUHDAS HIEKKA          |  | HEIKKO LIKAMAA            |
|  | HUUHTOUTUNUT MAA       |  | LIKAMAA                   |
|  | PUNERTAVA LIKAMAA      |  | HIILI, NOKIMAA            |
|  | PUNAINEN LIKAMAA       |  | KIVI                      |
|  | PUNAISEKSI PALANUT MAA |  | KANTO, JUURI              |
|   |                        |  | RUNSAASTI PALANUTTA LUUTA |

# SOTKAMO RÄÄTÄKANGAS

ESA SUOMINEN 1999

RUUDUT 502/126-130, 504/126-128, 506/116-128, 508/114-130  
510/114, 120, 512/114-120, 514/114-120

TASO 2

MK 1:50 

KP 204 = 162,12 m mpy

PIIRT. L. MANNINEN

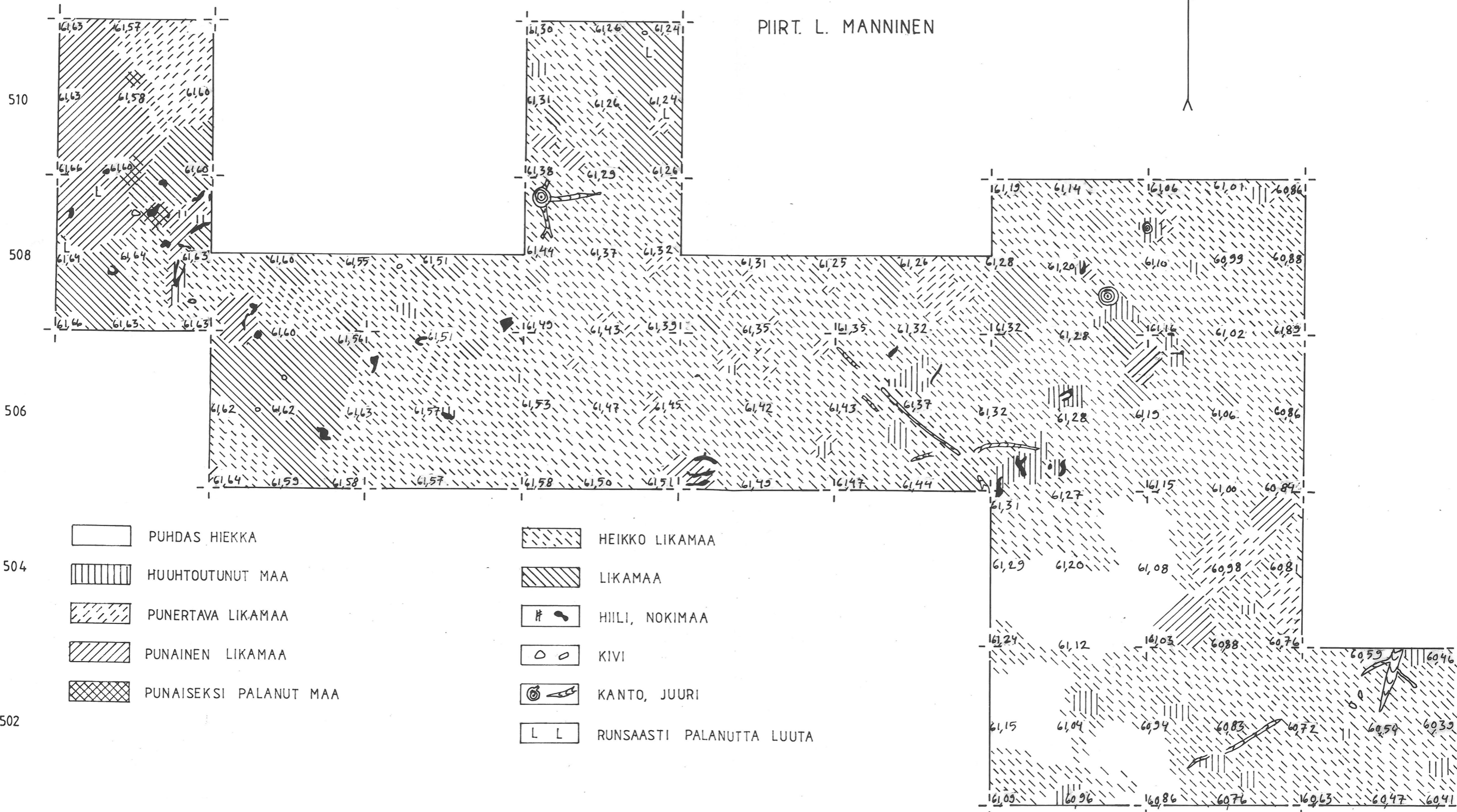
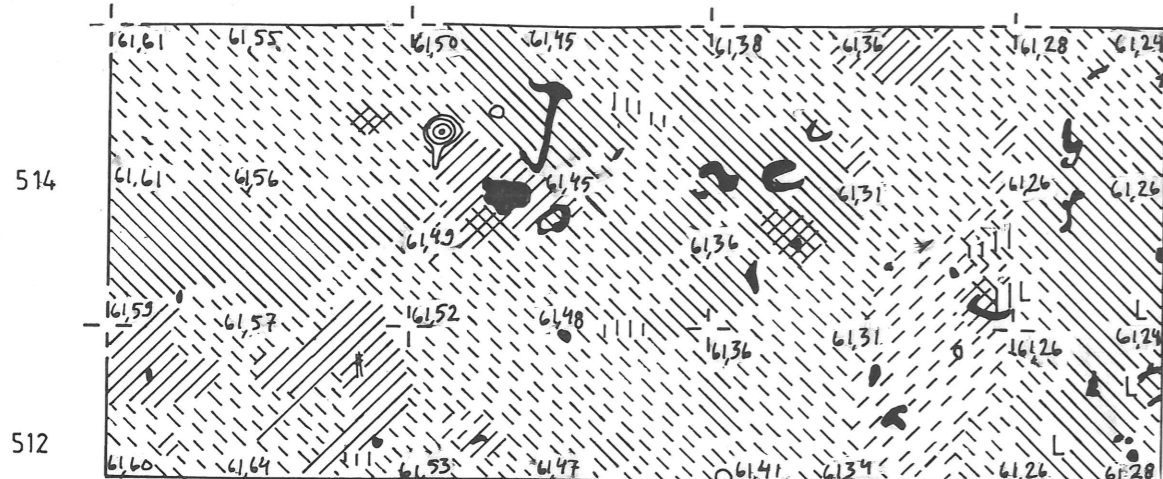

# SOTKAMO RÄÄTÄKANGAS

ESA SUOMINEN 1999

RUUDUT 502/126-130, 504/126-128, 506/116-128, 508/114-130,  
510/114, 120, 512/114-120, 514/114-120



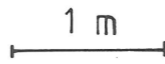

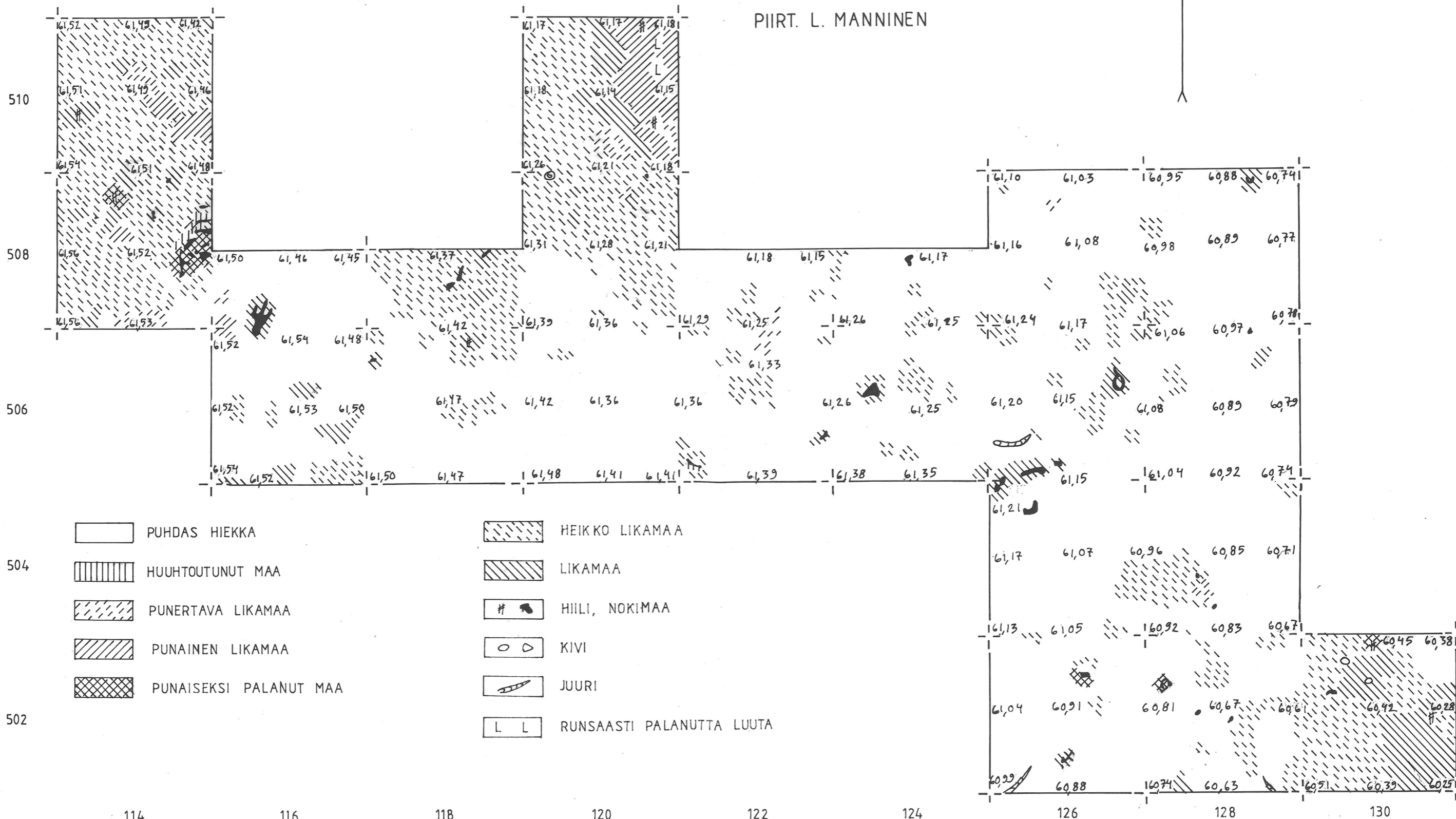
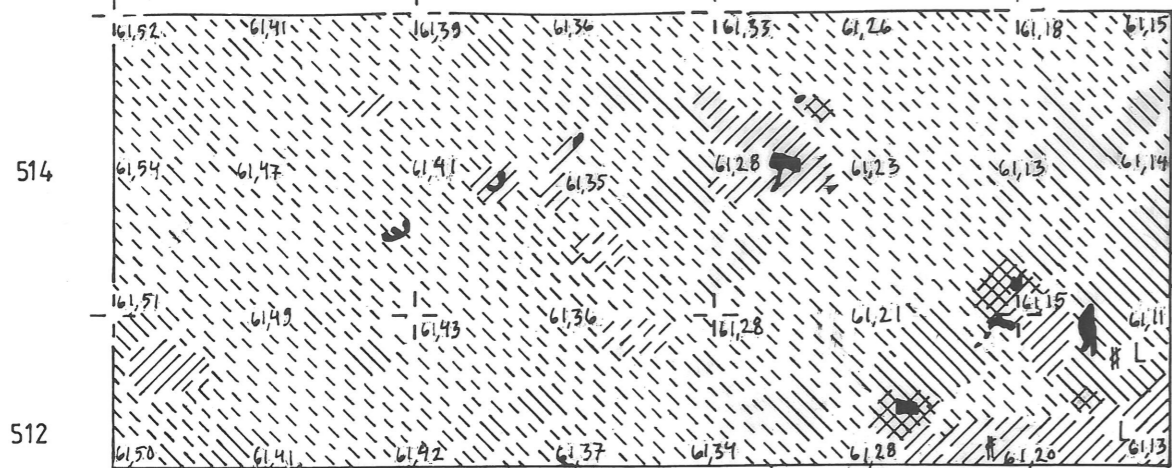

TASO 3

MK 1:50 

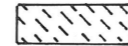
KP 204 = 162.12 m mpy

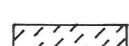
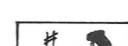
PIIRT. L. MANNINEN

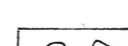
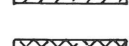
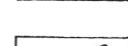

- |  |   |
|--|---|
|  PUHDAS HIEKKA          |  HEIKKO LIKAMAA            |
|  HUUHTOUTUNUT MAA       |  LIKAMAA                   |
|  PUNERTAVA LIKAMAA      |  HIILI, NOKIMAA            |
|  PUNAINEN LIKAMAA       |  KIVI                      |
|  PUNAISEKSI PALANUT MAA |  JUURI                     |
|  |  RUNSAASTI PALANUTTA LUUTA |

# SOTKAMO RÄÄTÄKANGAS

ESA SUOMINEN 1999

RUUDUT 502/126-130, 504/126-128, 506/116-128, 508/114-130, 510/114, 120,  
512/114-120, 514/114-120

TASO 4

MK 1:50 

KP 204 = 162,12m mpy

PIIRT. L. MANNINEN

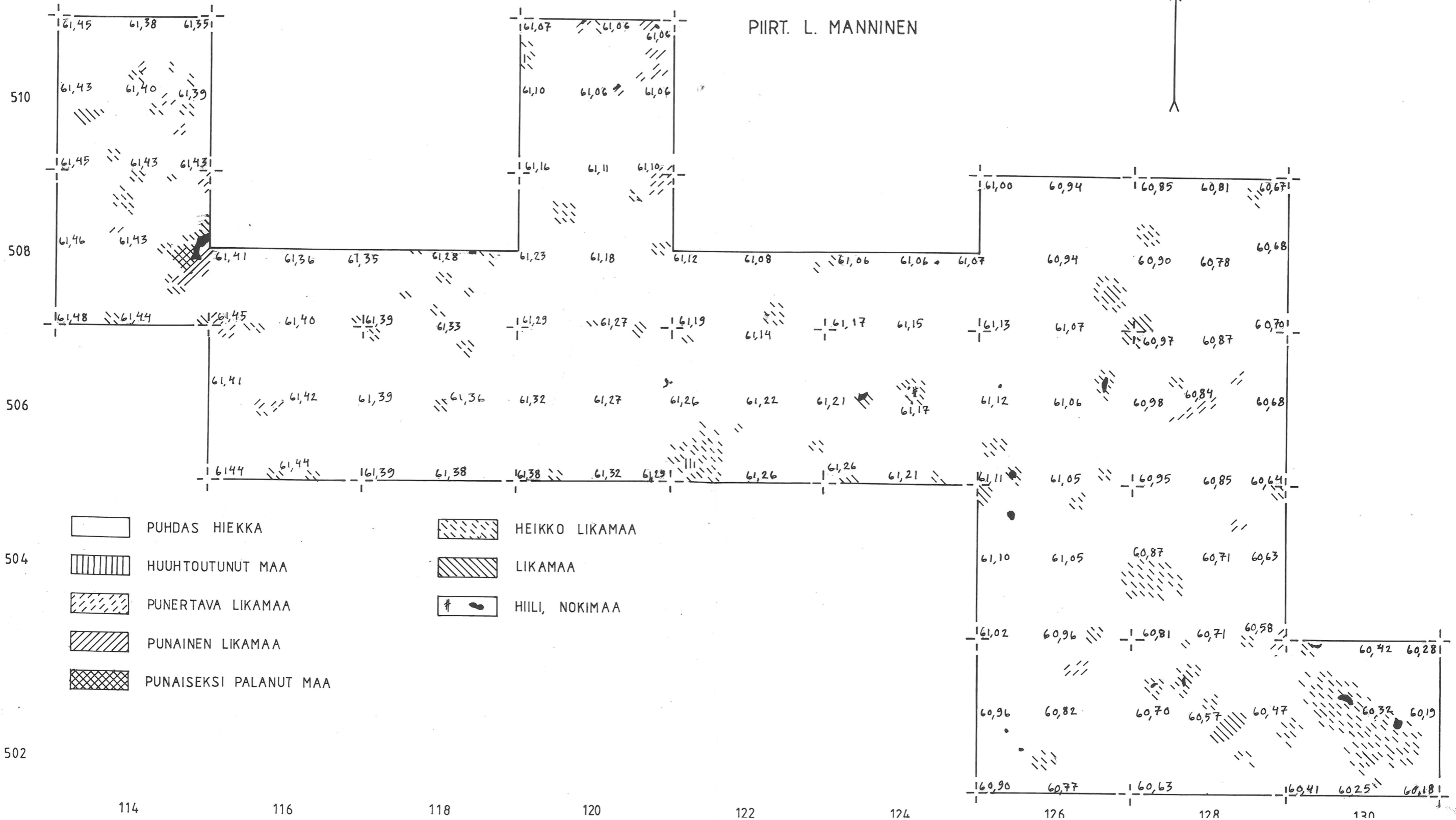
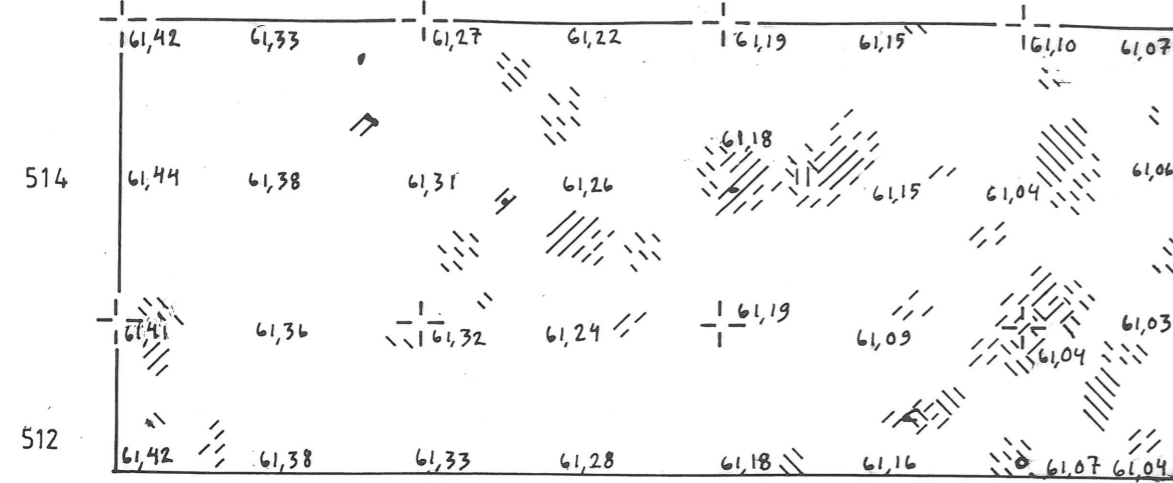

## SOTKAMO RÄÄTÄKANGAS

ESA SUOMINEN 1999

RUUDUT 502/128-130

TASO 5

MK 1:50 

KP 204 = 162,12 m mpy

PIIRT. L. MANNINEN

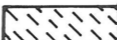
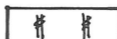
-  PUHDAS HIEKKA
-  HEIKKO LIKAMAA
-  HIILI

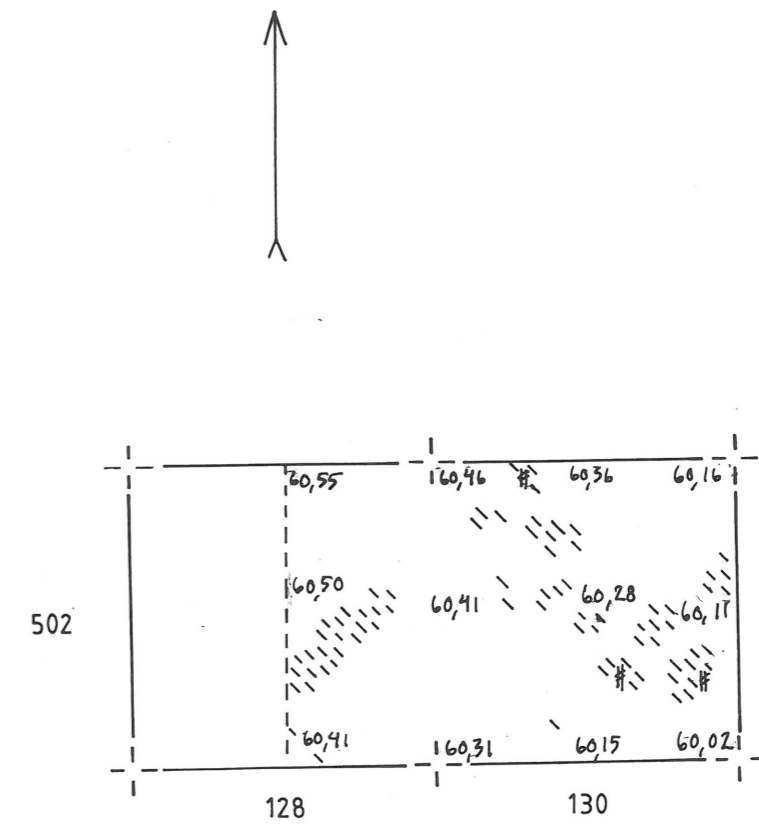

# SOTKAMO RÄÄTÄKANGAS

ESA SUOMINEN 1999

RUUDUT 426-428/130, 450-458/124-132

PINTA- JA POHJALUVUT

MK 1:50  1 m

KP 101 = 162,12 m mpy

PIIRT. L. MANNINEN

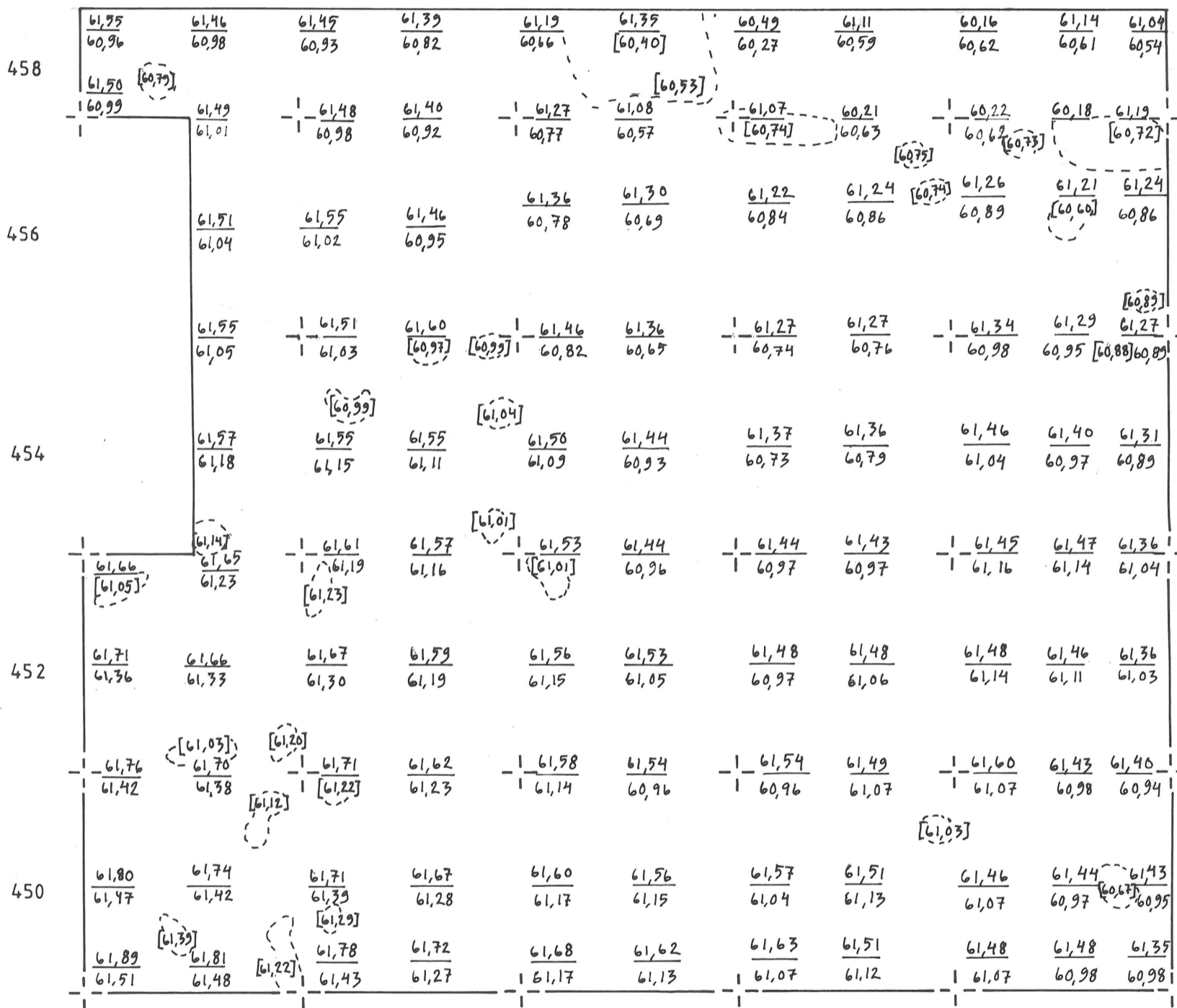

$\frac{61,76}{61,42}$  PINTALUKU  
POHJALUKU

$\frac{61,22}{61,22}$  KUOPPA

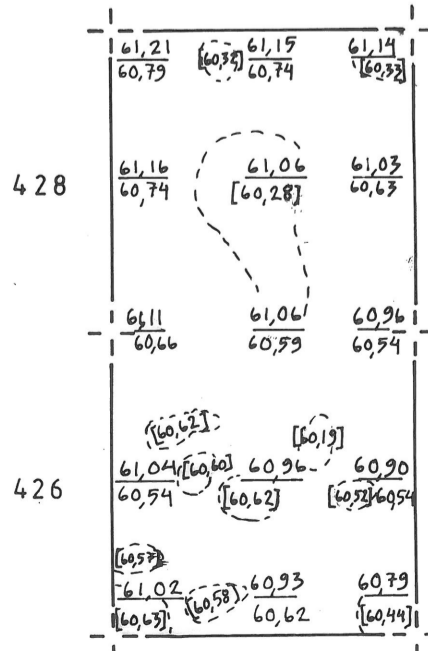



# SOTKAMO RÄÄTÄKANGAS

ESA SUOMINEN 1999

27

RUUDUT 426-428/130, 450-458/124-132



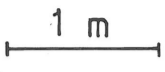

TASO 1

MK 1:50 

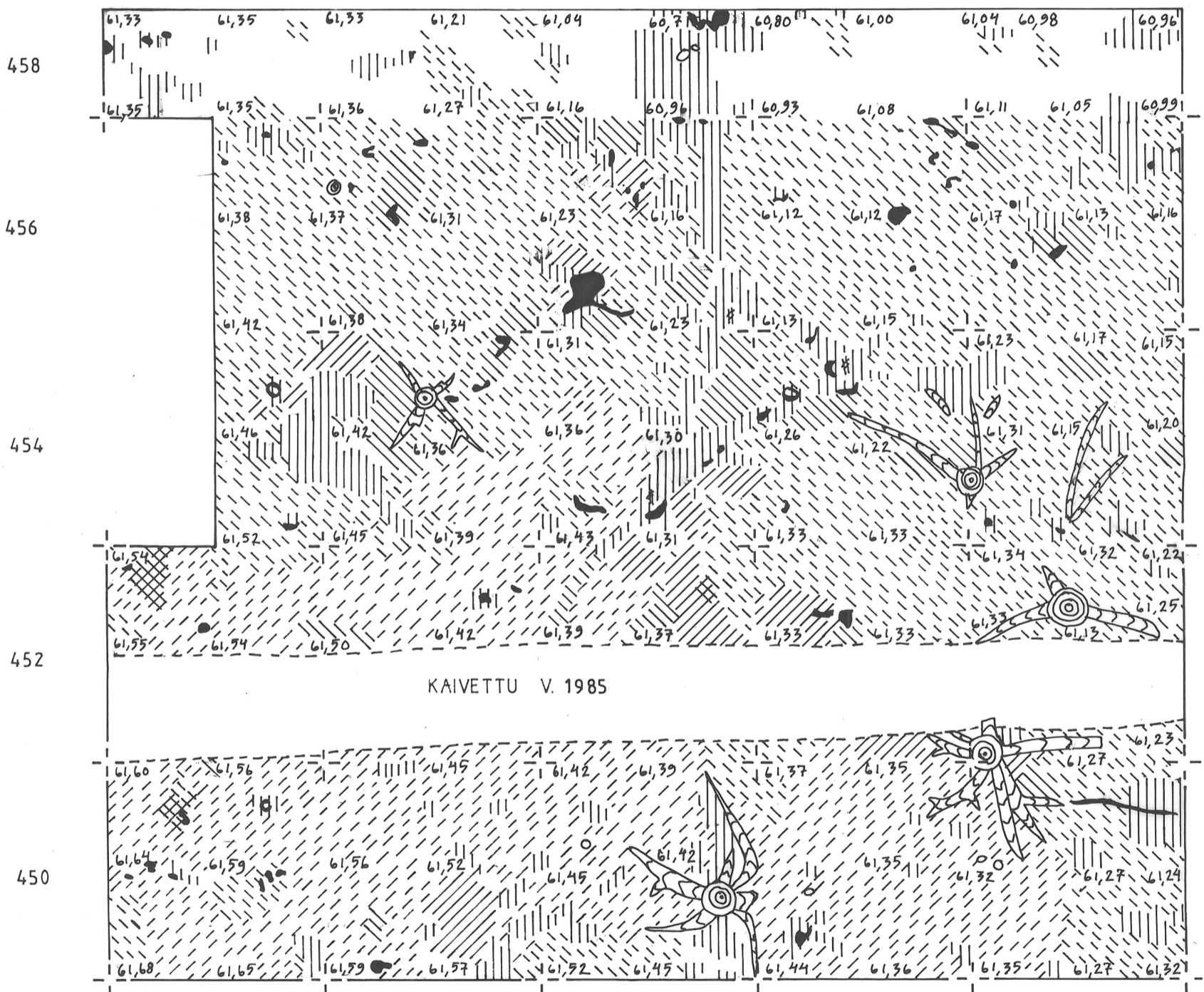
KP 101 = 162.12 m mpy

PIIRT. L. MANNINEN



- |   |                        |   |                |
|---|------------------------|---|----------------|
|  | PUHDAS HIEKKA          |  | HEIKKO LIKAMAA |
|  | HUUHTOUTUNUT MAA       |  | LIKAMAA        |
|  | PUNERTAVA LIKAMAA      |  | HIILI, NOKIMAA |
|  | PUNAINEN LIKAMAA       |  | KIVI           |
|  | PUNAISEKSI PALANUT MAA |  | KANTO, JUURI   |

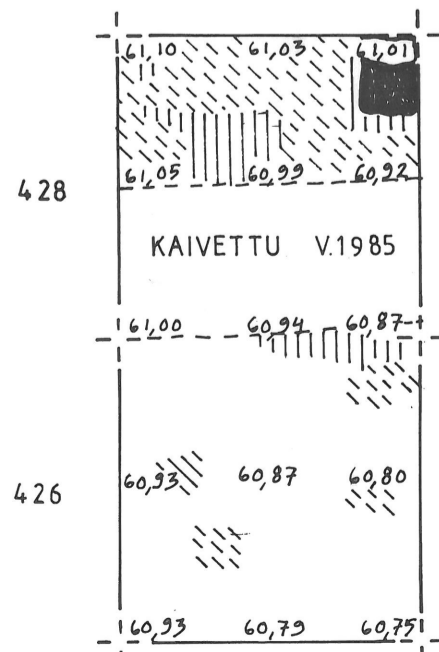

# SOTKAMO RÄÄTÄKANGAS

ESA SUOMINEN 1999

RUUDUT 426-428 /130, 450-458/124-132









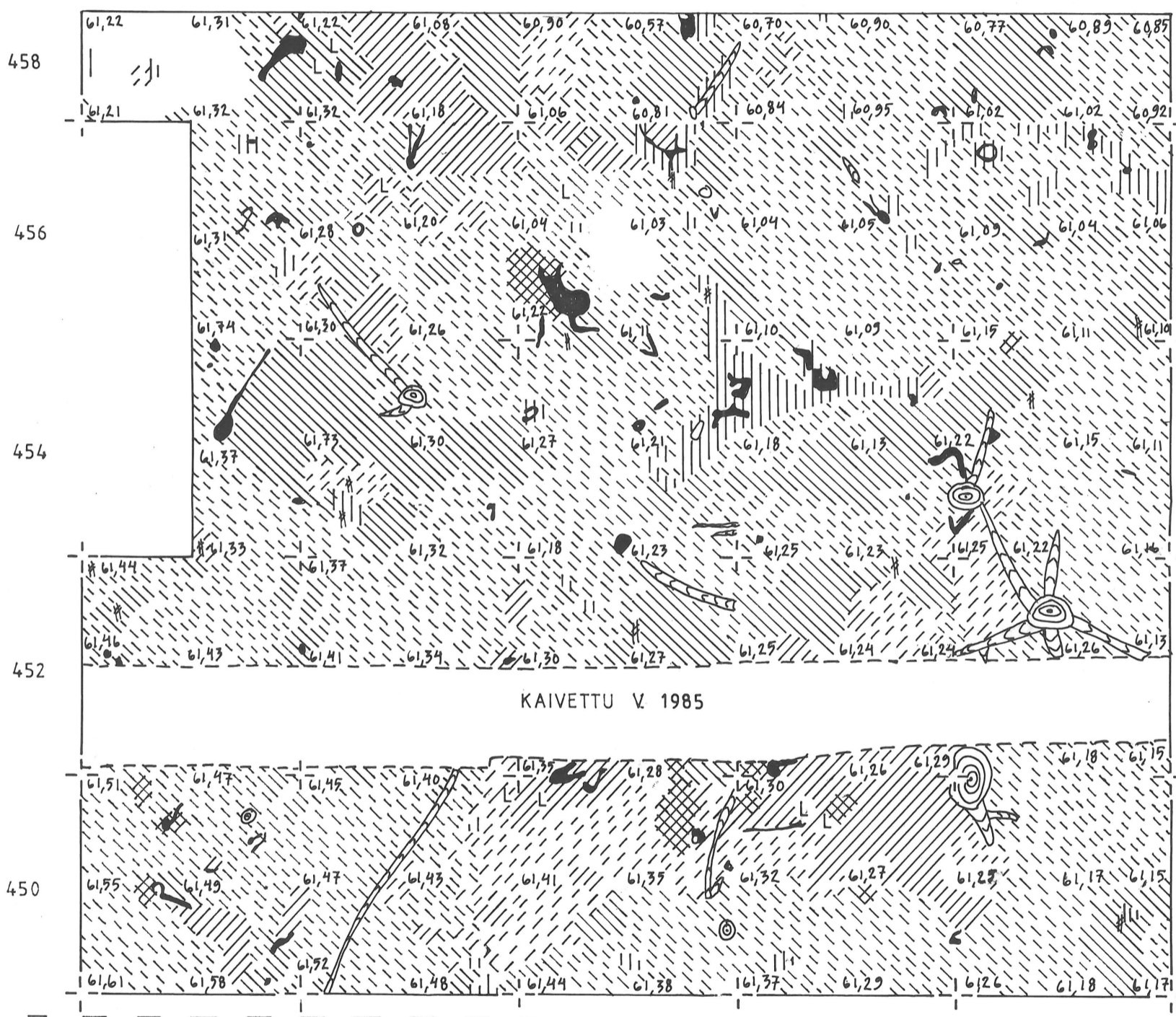

TASO 2

MK 1:50 

KP 101 = 162.12 m mpy

PIIRT. L. MANNINEN



- |   |                           |   |                |
|---|---------------------------|---|----------------|
|  | PUHDAS HIEKKA             |  | HEIKKO LIKAMAA |
|  | HUUHTOUTUNUT MAA          |  | LIKAMAA        |
|  | PUNERTAVA LIKAMAA         |  | HIILI, NOKIMAA |
|  | PUNAINEN LIKAMAA          |  | KIVI           |
|  | PUNAISEKSI PALANUT MAA    |  | KANTO, JUURI   |
|  | RUNSAASTI PALANUTTA LUUTA |   |                |

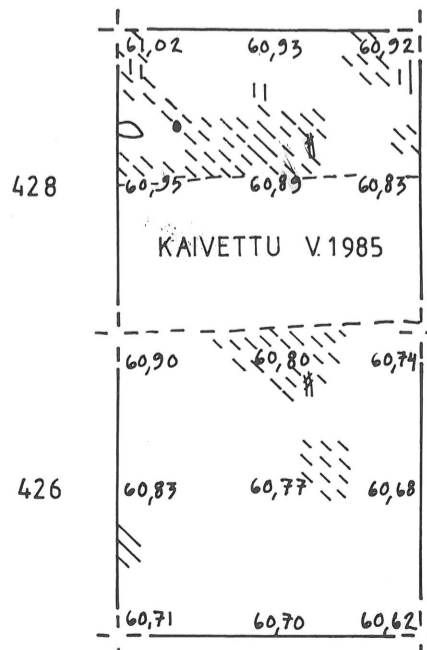

# SOTKAMO RÄÄTÄKANGAS

ESA SUOMINEN 1999

RUUDUT 426-428 / 130, 450-458/124-132



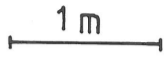





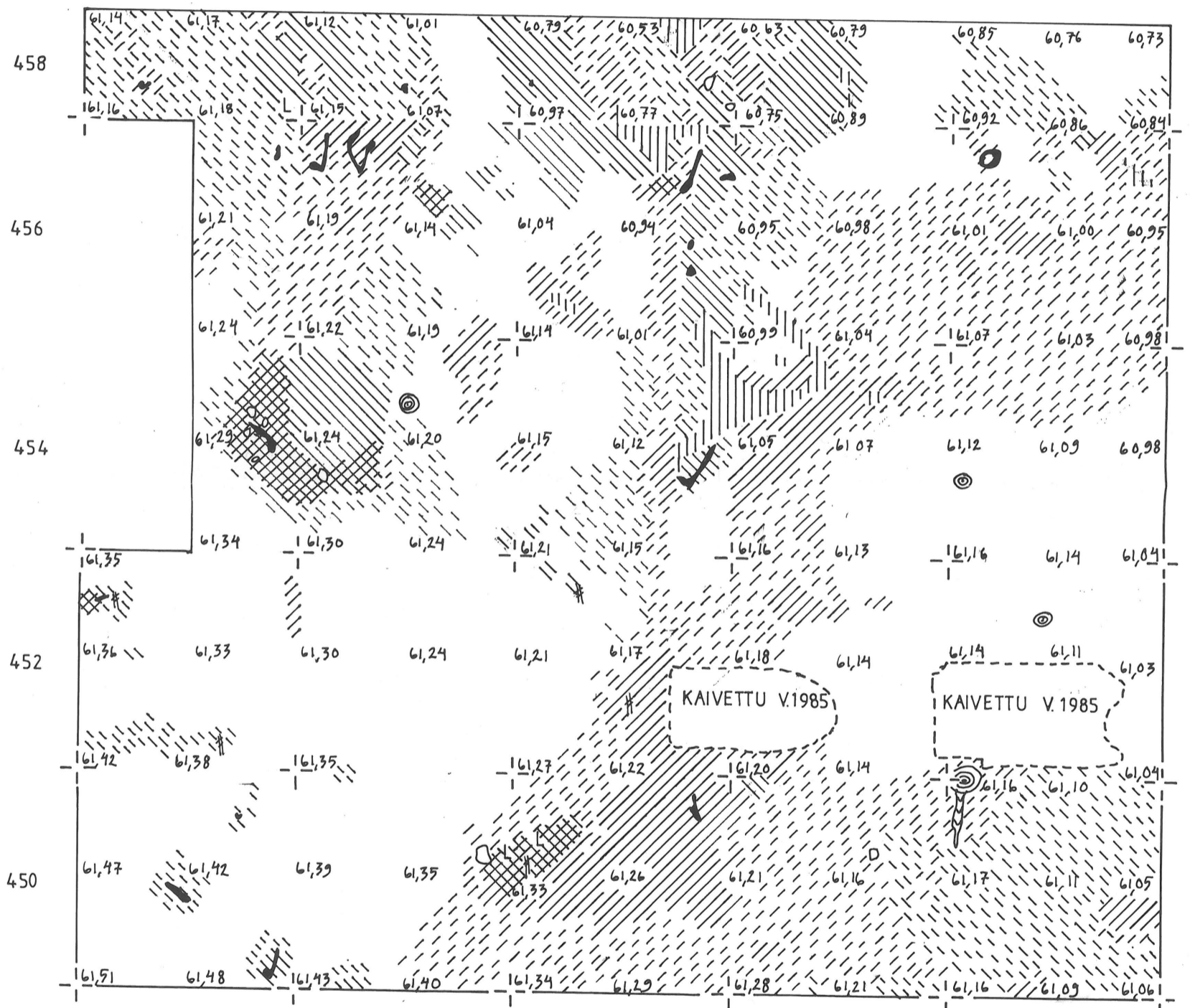

TASO 3

MK 1:50 

KP 101 = 162.12 m mpy

PIIRT. L. MANNINEN



- |   |                           |   |                |
|---|---------------------------|---|----------------|
|  | PUHDAS HIEKKA             |  | HEIKKO LIKAMAA |
|  | HUUHTOUTUNUT MAA          |  | LIKAMAA        |
|  | PUNERTAVA LIKAMAA         |  | HIIPI, NOKIMAA |
|  | PUNAINEN LIKAMAA          |  | KIVI           |
|  | PUNAISEKSI PALANUT MAA    |  | KANTO, JUURI   |
|  | RUNSAASTI PALANUTTA LUUTA |   |                |

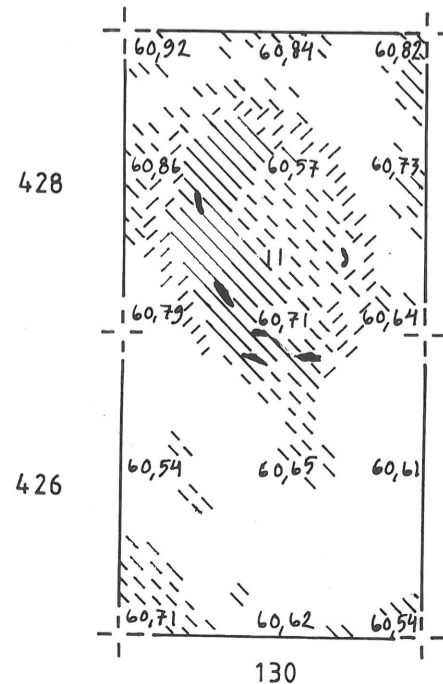

# SOTKAMO RÄÄTÄKANGAS

ESA SUOMINEN 1999

RUUDUT 426 - 428/130, 450/126-132, 452/126-130, 454-458/124-132









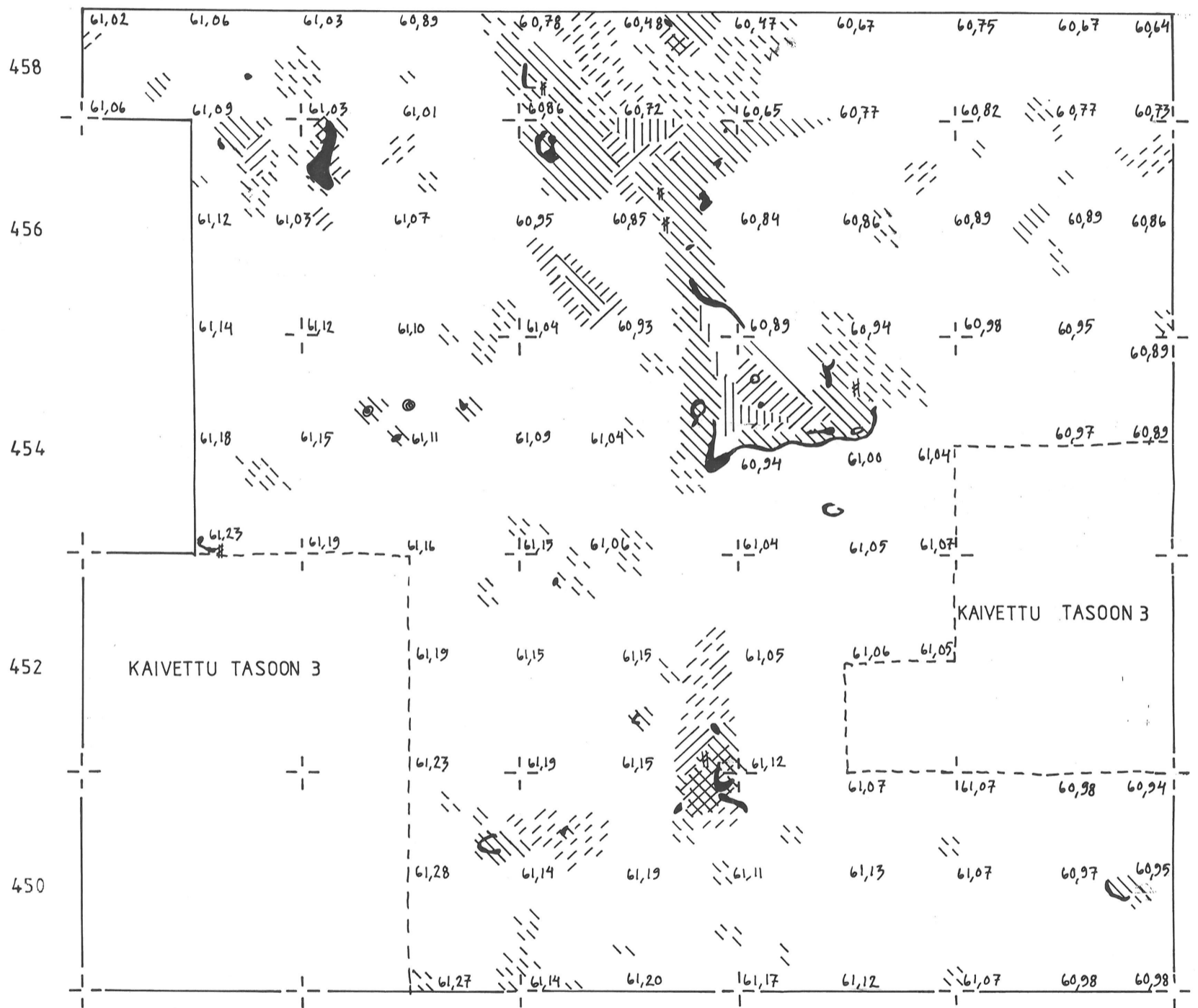

TASO 4

MK 1:50 

KP 101 = 162,12 m mpy

PIIRT. L. MANNINEN



- |   |                        |   |                |
|---|------------------------|---|----------------|
|  | PUHDAS HIEKKA          |  | HEIKKO LIKAMAA |
|  | HUUHTOUTUNUT MAA       |  | LIKAMAA        |
|  | PUNERTAVA LIKAMAA      |  | HIILI, NOKIMAA |
|  | PUNAINEN LIKAMAA       |  | KIVI           |
|  | PUNAISEKSI PALANUT MAA |  | KANTO          |

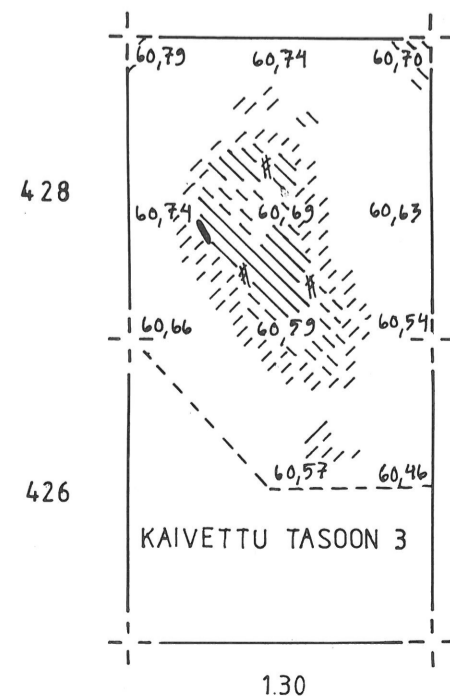

# SOTKAMO RÄÄTÄKANGAS

ESA SUOMINEN 1999

RUUDUT 426-428/130, 450/128-130, 452/128, 454/128-130, 456/124-128, 458/124-132





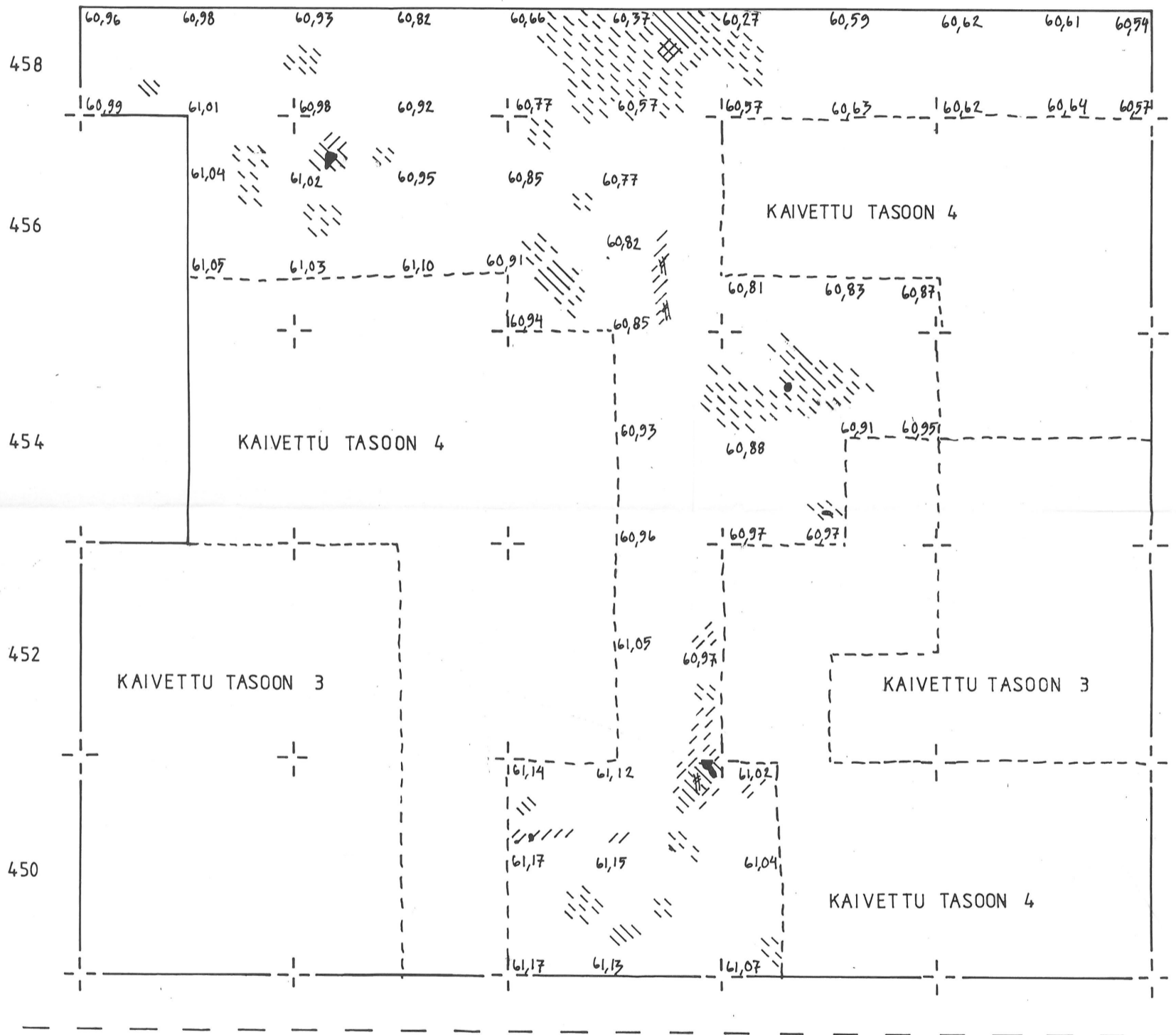

TASO 5

MK 1:50 

KP 101 162,12 m mpy

PIIRT. L. MANNINEN



-  PUHDAS HIEKKA
-  PUNERTAVA LIKAMAA
-  PUNAINEN LIKAMAA
-  PUNAISEKSI PALANUT MAA
-  HEIKKO LIKAMAA
-  LIKAMAA
-  HIILI, NOKI

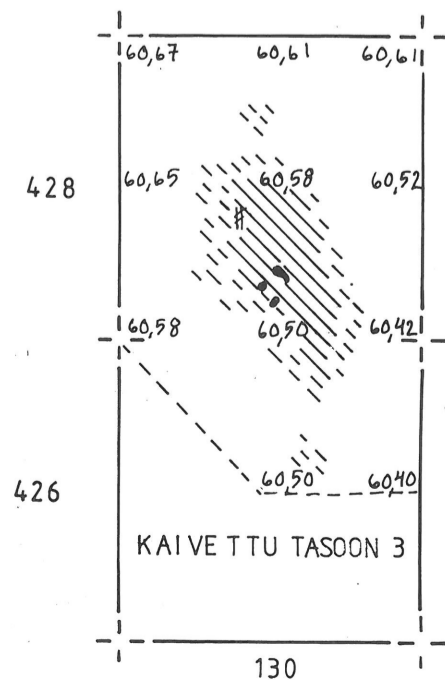

# SOTKAMO RÄÄTÄKANGAS

ESA SUOMINEN 1999





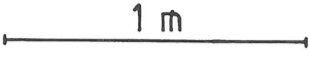





RUUDUT 452-456/128

PROFIILI POHJOIS-ETELÄ-SUUNTAISESTA SEINÄMASTÄ LÄNNESTÄ KATSOTTUNA

MK 1:25 

KP 101 162,12 m mpy

PIIRT. L. MANNINEN

- |  |  |  |
|--|--|--|
|  PUHDAS HIEKKA             |  PUNAINEN LIKAMAA |  HIILI, NOKIMAA           |
|  TURVE JA HUUHTOUTUNUT MAA |  HEIKKO LIKAMAA   |  TÄYTEMÄÄ                 |
|  PUNERTAVA LIKAMAA         |  LIKAMAA          |  RUNSASTI PALANEITA LUITA |
|  |  |  KIVI                     |

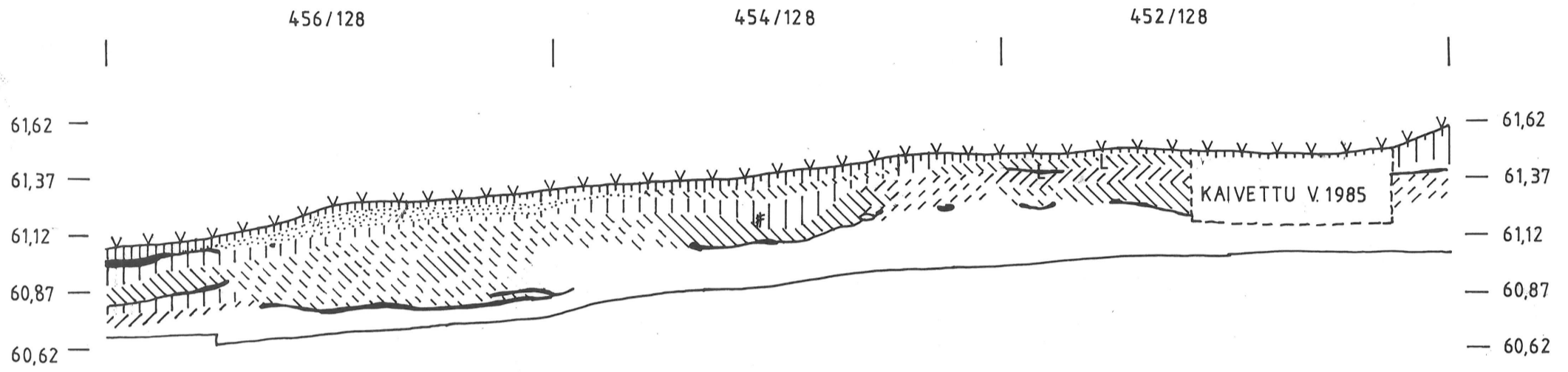

A. PINTAPROFIILI ETELÄ - POHJOINEN, 449,5-459,75 / 59,50

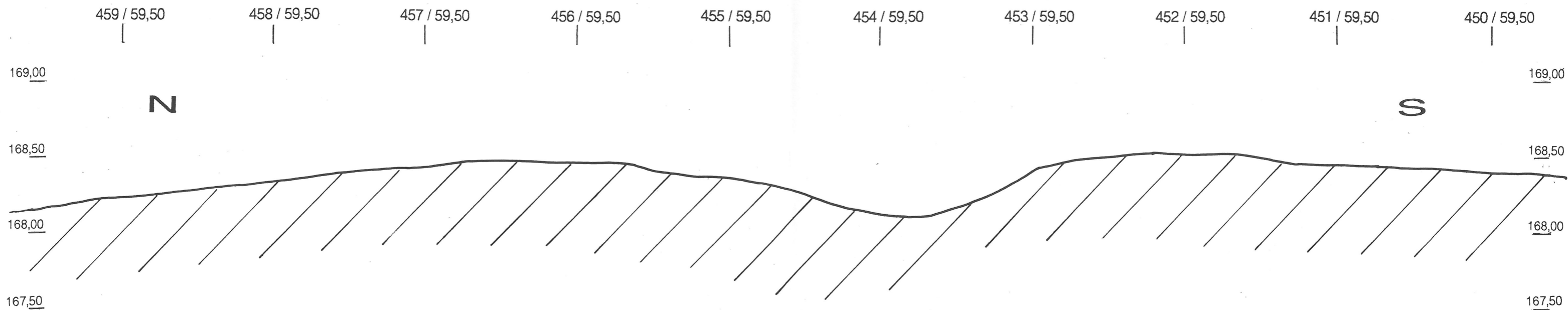

B. PINTAPROFIILI LÄNSI - ITÄ, 454 / 54-64

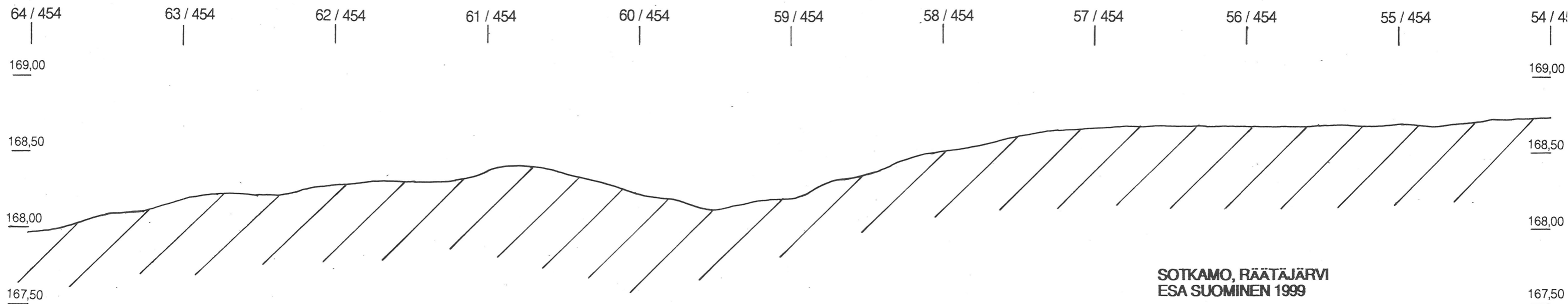

SOTKAMO, RÄÄTÄJÄRVI  
ESA SUOMINEN 1999

PYYNTIKUOPPA 1  
PINTAVAAITUSKARTAT A ja B

Mk 1:25    1 M

Vaakitus Esa Suominen, Leena Manninen  
Piirros Markku Korteniemi

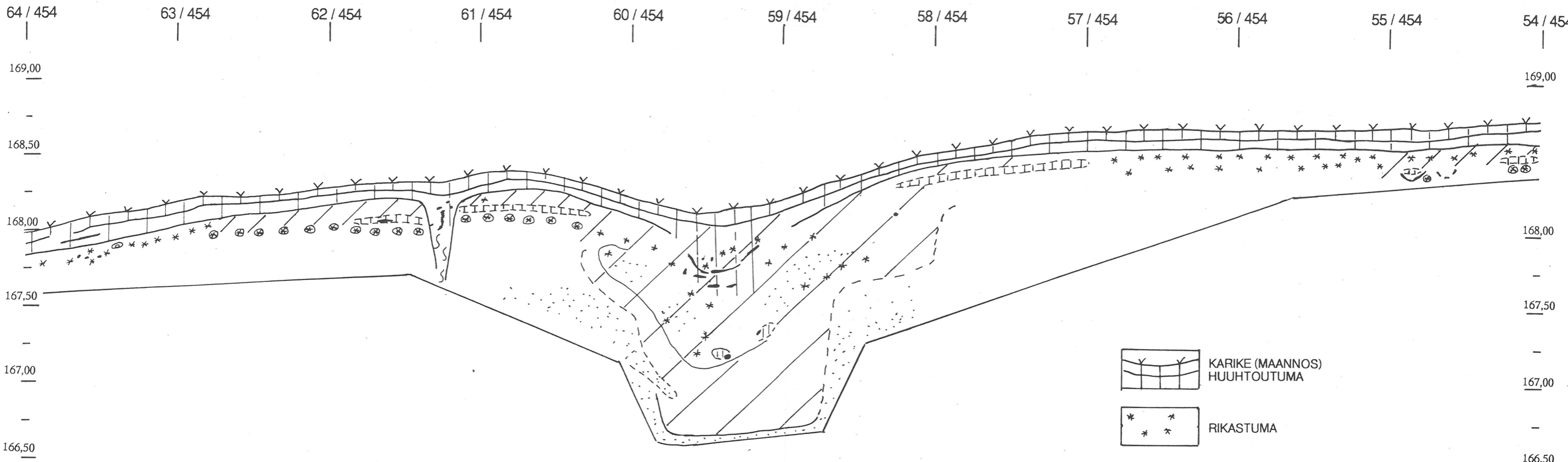





**SOTKAMO, RÄÄTÄJÄRVI  
ESA SUOMINEN 1999**

PYYNTIKUOPPA 1  
LEIKKAUSPROFIILI, LÄNSI-ITÄ 454 / 54-64

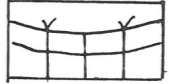
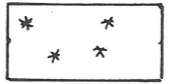
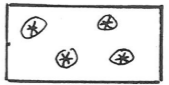
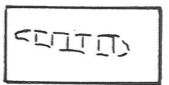
Mk 1:25  1 M

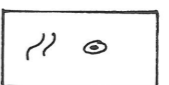
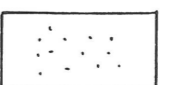
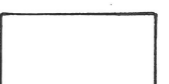
Vaakitus Esa Suominen, Leena Manninen  
Piirros Markku Korteniemi

-  KARIKE (MAANNOS)  
HUUHTOUTUMA
-  RIKASTUMA
-  FOSS. RIKASTUMA
-  FOSS. HUUHTOUTUMA
-  LIIKKUNUT / SEKOITTUNUT MAA
-  NOKEA / HIILTÄ
-  JUURIA
-  SAVEA (MYÖS LUSTOJA)
-  KOSKEMATTOMIA HIEKKALUSTOJA
-  KOSKEMATTOMAN MAAN RAJA
-  KAIKETUN ALUEEN RAJA